

TOSHIBA

FILE No. A10-1902

SERVICE MANUAL

AIR-CONDITIONER

SPLIT TYPE

OUTDOOR UNIT

<SUPER DIGITAL INVERTER>

RAV-GP1101AT8-E

RAV-GP1101AT8-TR

RAV-GP1101AT8J-E

RAV-GP1101AT8J-TR

RAV-GP1401AT8-E

RAV-GP1401AT8-TR

RAV-GP1401AT8J-E

RAV-GP1401AT8J-TR

RAV-GP1601AT8-E

RAV-GP1601AT8-TR

RAV-GP1601AT8J-E

RAV-GP1601AT8J-TR

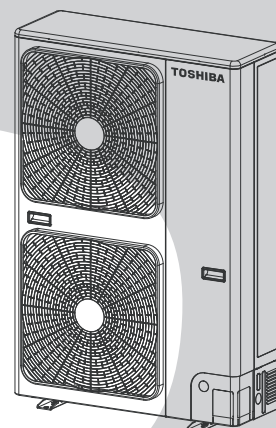

4. WIRING DIAGRAM

4-1. Outdoor Unit

RAV-GP1101AT8(J)-E, -TR RAV-GP1401AT8(J)-E, -TR RAV-GP1601AT8(J)-E, -TR

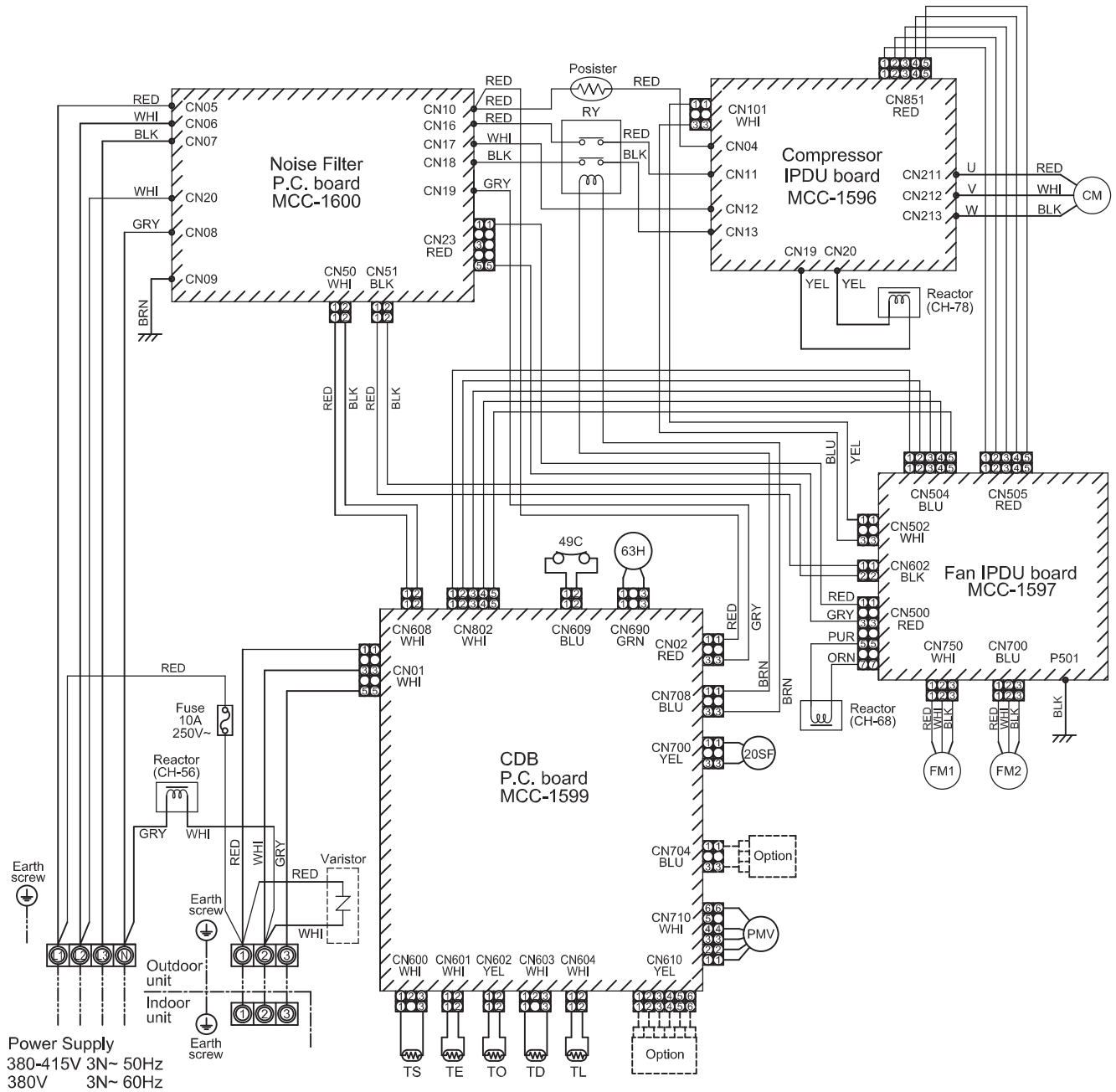

Symbol	Part name
CM	Compressor
FM1,2	Fan motor
PMV	Pulse motor valve
TD	Pipe temperature sensor (Discharge)
TS	Pipe temperature sensor (Suction)
TE	Heat exchanger sensor 1
TL	Heat exchanger sensor 2
TO	Outside temperature sensor
20SF	4-way valve coil
49C	Compressor case thermostat
63H	High-pressure switch
RY	Relay

Color Identification	
BLK : BLACK	WHI : WHITE
BLU : BLUE	BRN : BROWN
RED : RED	ORN : ORANGE
GRY : GRAY	YEL : YELLOW
GRN : GREEN	PUR : PURPLE

1. Ⓞ indicates the terminal block. Alphanumeric characters in the cycle indicate the terminal No.
2. The two-dot chain line indicates the wiring procured locally.
3. ▨ indicates the P.C. board.
4. For the indoor unit circuit, refer to the wiring diagram of the indoor unit.

Outdoor Unit
RAV-GP1401AT8-E, RAV-GP1401AT8J-E
RAV-GP1401AT8-TR, RAV-GP1401AT8J-TR

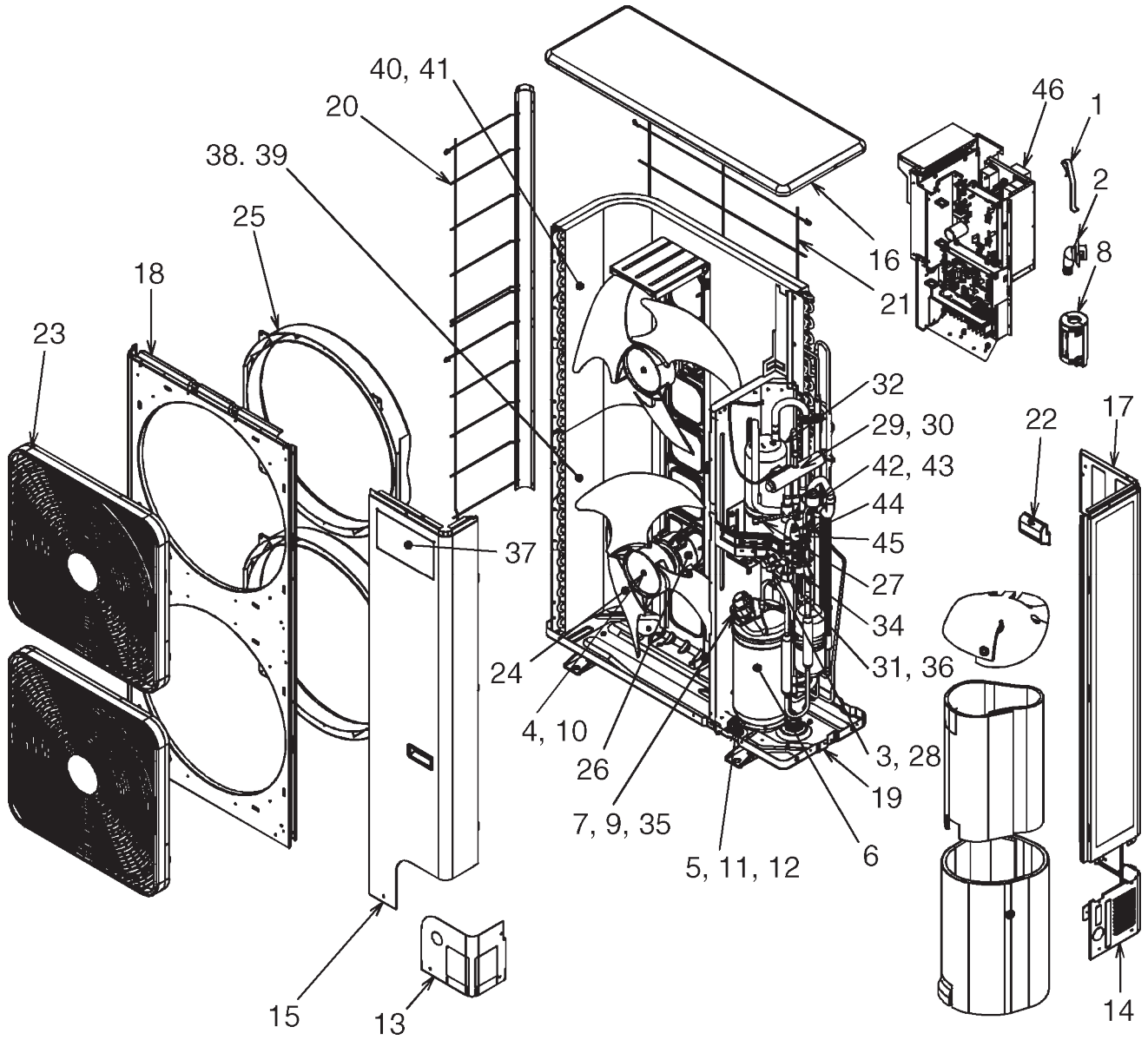

Location No.	Part No.	Description	Model name	RAV-GP
			1401AT8-E 1401AT8-TR	1401AT8J-E 1401AT8J-TR
1	43F19904	HOLDER, SENSOR (TS)	3	3
2	43F32441	NIPPLE, DRAIN	1	1
3	43F47401	BONNET, 3/8 IN	1	1
4	43F47669	NUT, FLANGE	2	
5	43049739	CUSHION, RUBBER	3	3
6	43141530	COMPRESSOR, RX420A3F-27M	1	1
7	43F50407	THERMOSTAT,BIMETAL	1	1
8	43F60029	FILTER, NOISE	1	1
9	43F63317	HOLDER,THERMOSTAT	1	1
10	43197164	NUT, FLANGE		2
11	43197174	NUT, COMP		3
12	43F97212	NUT	3	
13	43100437	PANEL, FRONT, PIPING	1	1
14	43100438	PANEL, BACK, PIPING	1	1
15	43100439	PANEL, FRONT	1	1
16	43100440	PLATE, ROOF	1	1
17	43100470	PANEL, SIDE	1	1
18	43100442	PANEL, AIR OUTLET	1	1
19	43100443	BASE ASSY	1	1
20	43107274	GUARD, FIN, SIDE	1	1
21	43107275	GUARD, FIN, BACK	1	1
22	43107276	HANGER	3	3
23	43119540	GUARD, FAN ASSY	2	2
24	43120244	FAN, PROPELLER, PB521	2	2
25	43122113	BELL MOUTH	2	2
26	4312C100	MOTOR, FAN, ICF-280-A100-1 (A)	2	2
27	43146676	JOINT,CHECK	1	1
28	4314N092	VALVE, PACKED, 9.52	1	1
29	37546878	VALVE, 4-WAY, STF-H0404	1	1
30	4314N080	COIL, SOLENOID, STF-H01AJ1736A1	1	1
31	43146724	VALVE, BALL, SBV-JA5GTC-1, ROHS	1	1
32	43148294	ACCUMULATOR	1	1
34	43151301	SWITCH, PRESSURE	1	1
35	43160612	LEAD ASSY, COMPRESSOR	1	1
36	43147194	BONNET, 5/8 IN	1	1
37	4311M659	MARK, TOSHIBA	1	1
38	4314G266	CONDENSER ASSY, DOWN	1	
39	4314G268	CONDENSER ASSY, DOWN		1
40	4314G269	CONDENSER ASSY, UP	1	
41	4314G271	CONDENSER ASSY, UP		1
42	4314N023	VALVE, PLUS, MODULAING, UKV-25D100	1	1
43	4314N025	COIL, PMV, UKV-A038	1	1
44	4314Q031	STRAINER	1	1
45	4314Q032	STRAINER	1	1
46	43158227	REACTOR	1	1

14-2. Inverter Assembly

RAV-GP1101AT8(J)-E, RAV-GP1401AT8(J)-E, RAV-GP1601AT8(J)-E
 RAV-GP1101AT8(J)-TR, RAV-GP1401AT8(J)-TR, RAV-GP1601AT8(J)-TR

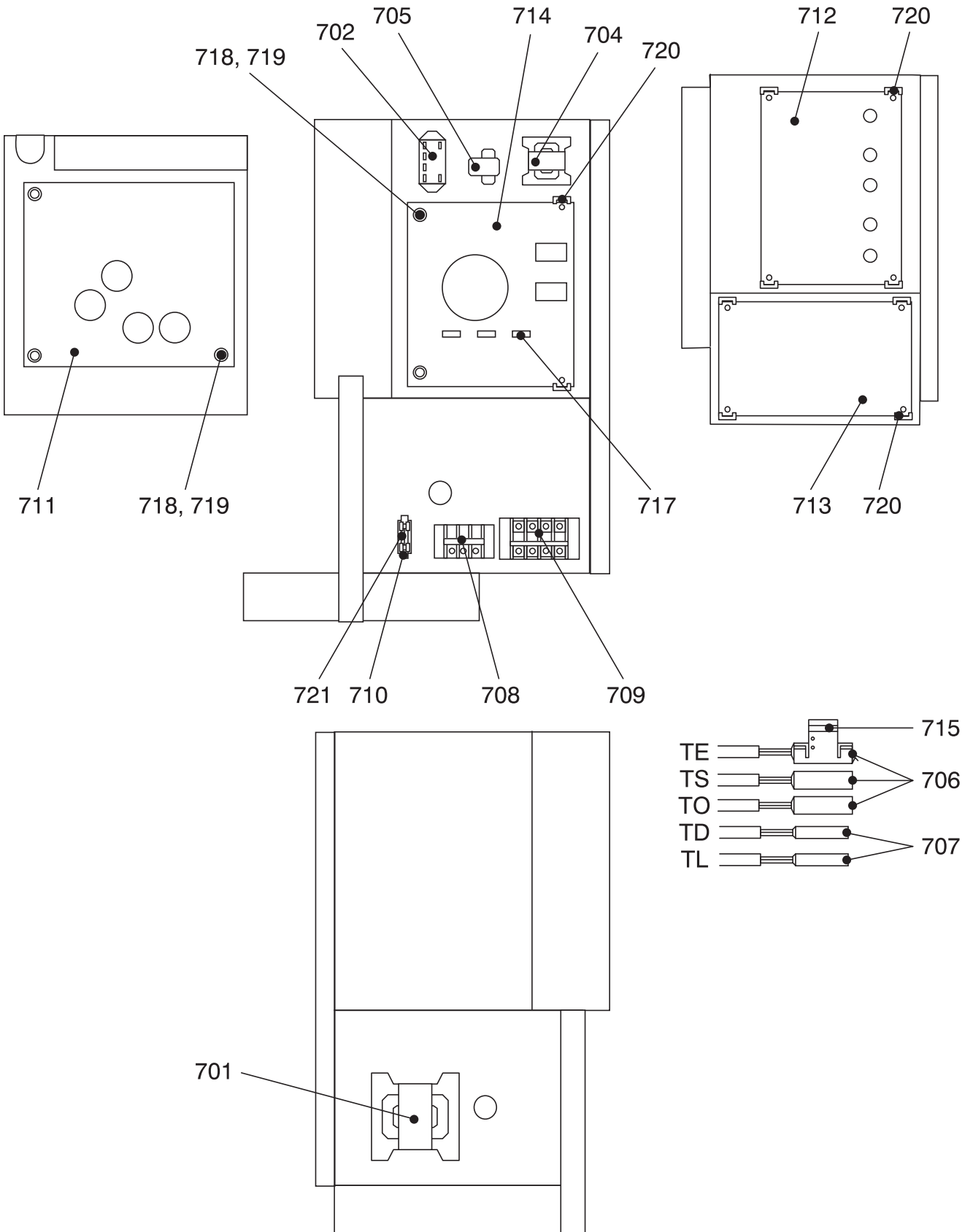

Location No.	Part No.	Description	Model name	RAV-GP
			1101AT8(J)-E, 1401AT8(J)-E, 1601AT8(J)-E 1101AT8(J)-TR, 1401AT8(J)-TR, 1601AT8(J)-TR	
701	43F58288	REACTOR, CH-56-4Z		1
702	43154177	RELAY		1
704	43158207	REACTOR, CH-68		1
705	43153006	PTC-THERMISTOR		1
706	43050425	SENSOR ASSY, SERVICE		3
707	43150319	SENSOR ASSY, SERVICE		2
708	43160565	TERMINAL BLOCK, 3P, 20A		1
709	43160579	TERMINAL, 30A, 4P		1
710	43F60859	FUSE BLOCK, 30A, 250V		1
711	4316V416	PC BOARD ASSY, MCC-1596, COMP-IPDU		1
712	4316V391	PC BOARD ASSY, MCC-1597, FAN-IPDU		1
713	4316V622	PC BOARD ASSY, MCC-1599, CDB		1
714	4316V398	PC BOARD ASSY, MCC-1600, N/F		1
715	43F63325	HOLDER, SENSOR (TE)		1
717	43160590	FUSE		3
718	43282001	BUSHING		5
719	43183020	COLLAR		5
720	43F63248	SUPPORTER, ASSY		2
721	43060700	FUSE, 10A, 250V		1