

Produkt Datenblatt

Gerätebezeichnung: MMD-UP00121BHP-E

Technische Daten

	Einheiten	Werte
Nennkühlleistung	kW	3,6
Nennheizleistung	kW	4,0
Leistungsaufnahme	kW	0,060
Max. Stromaufnahme	A	0,60
Luftvolumenstrom (m³/h)	m³/h	570 / 480 / 390
Schalldruckpegel (dBA)	dB (A)	30 / 26 / 23
Schalleistungspegel (dBA)	dB (A)	45 / 41 / 38
Statischer Außendruck	Pa	30 - 150
Abmessungen (HxBxT)	mm	275 x 750 x 700
Gewicht	kg	23
Saugasl. Bördel	mm	9,5
Flüssigkeitsl. Bördel	mm	6,4
Kondensat Anschluss		VP25
Betriebsspannung	V- Hz	220 - 240V ~ 50Hz 208 - 230V ~ 60Hz

Abbildung:



Maßskizze:

MMD-UP0051BHP-E, MMD-UP0071BHP-E(TR), MMD-UP0091BHP-E(TR), MMD-UP0121BHP-E(TR),
MMD-UP0151BHP-E(TR), MMD-UP0181BHP-E(TR), MMD-UP0241BHP-E(TR), MMD-UP0271BHP-E(TR),
MMD-UP0301BHP-E(TR), MMD-UP0361BHP-E(TR), MMD-UP0481BHP-E(TR), MMD-UP0561BHP-E(TR)

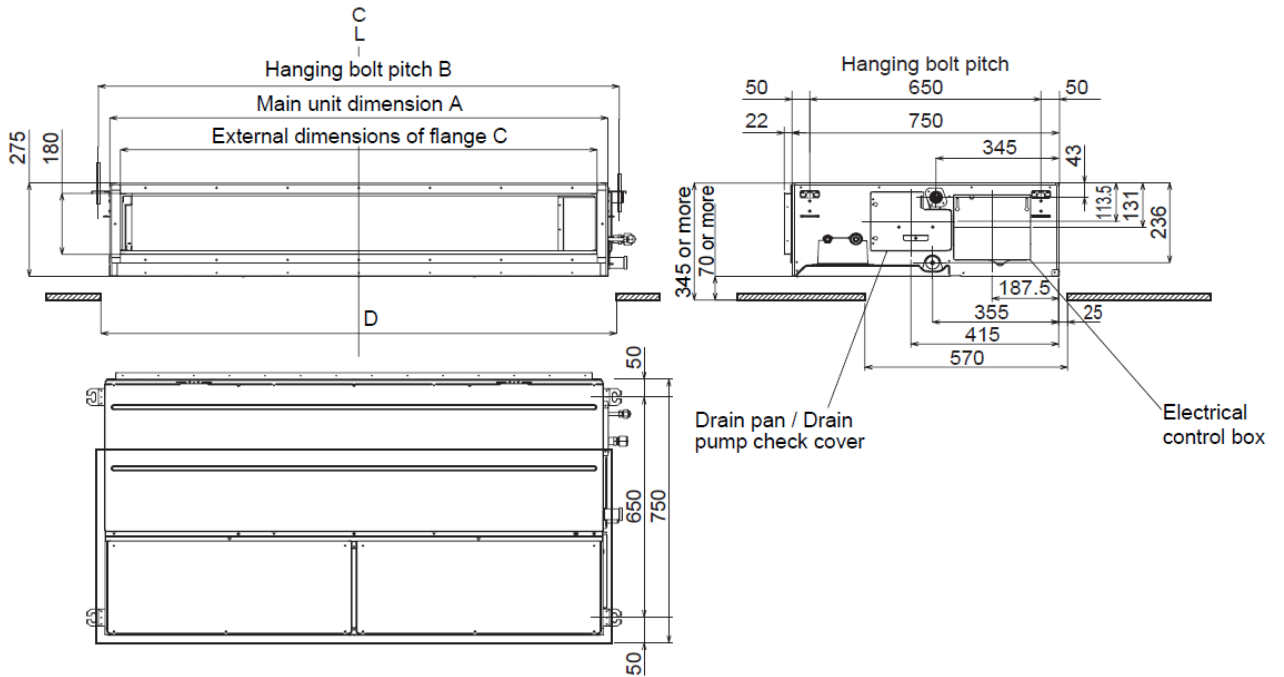

Dimension

	A	B	C	D	E
UP005 ~ 018 type	700	765	640	750	700
UP024 ~ 030 type	1000	1065	940	1050	500
UP036 ~ 056 type	1400	1465	1340	1450	700

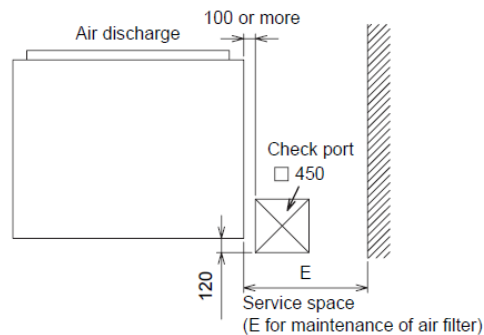

UP005 ~ UP018 type

<Under air intake>

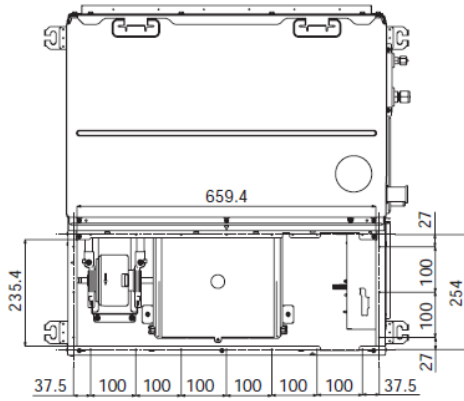

UP024 ~ UP030 type

<Under air intake>

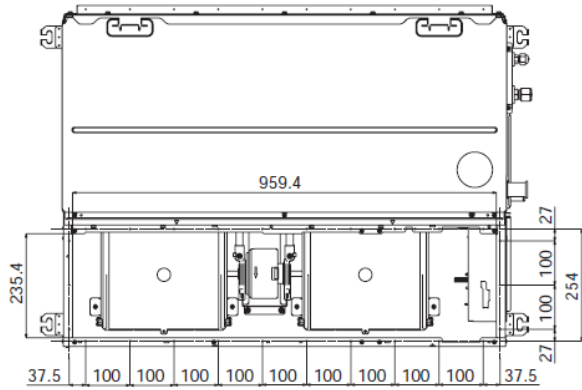

<Back air intake>

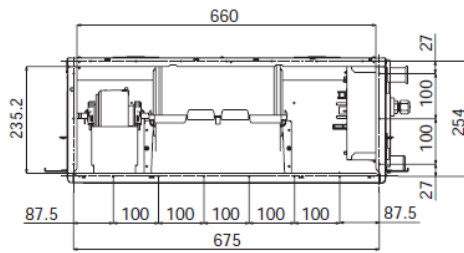

<Back air intake>

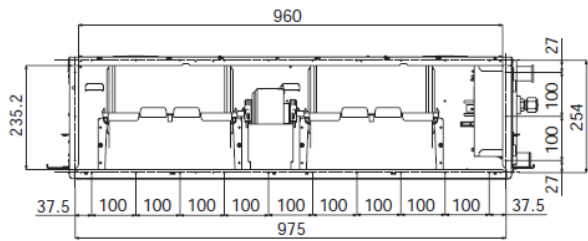

UP036 ~ UP056 type

<Under air intake>

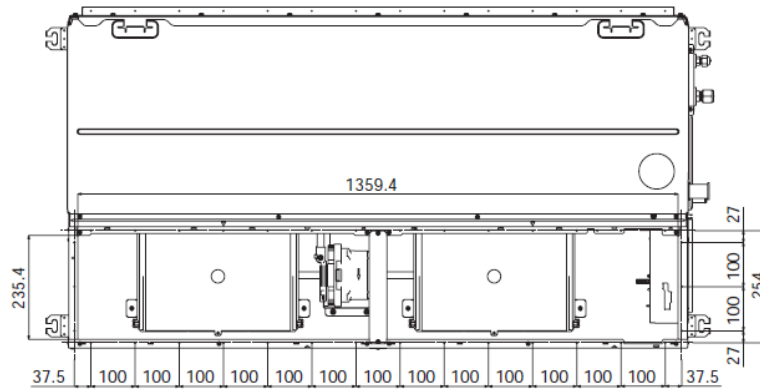

<Back air intake>

