

TOSHIBA

FILE No. A10-1902

SERVICE MANUAL

AIR-CONDITIONER

SPLIT TYPE

OUTDOOR UNIT

<SUPER DIGITAL INVERTER>

RAV-GP1101AT8-E

RAV-GP1101AT8-TR

RAV-GP1101AT8J-E

RAV-GP1101AT8J-TR

RAV-GP1401AT8-E

RAV-GP1401AT8-TR

RAV-GP1401AT8J-E

RAV-GP1401AT8J-TR

RAV-GP1601AT8-E

RAV-GP1601AT8-TR

RAV-GP1601AT8J-E

RAV-GP1601AT8J-TR

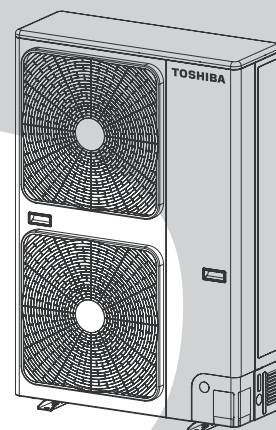

CONTENTS

Precaution for Safety	7
1. SPECIFICATIONS	17
1-1. Outdoor Unit	17
1-2. Operation Characteristic Curve	18
2. CONSTRUCTION VIEWS (EXTERNAL VIEWS).....	19
2-1. Outdoor Unit	19
3. OUTDOOR UNIT REFRIGERATING CYCLE DIAGRAM	22
4. WIRING DIAGRAM	23
4-1. Outdoor Unit	23
5. SPECIFICATIONS OF ELECTRICAL PARTS	24
5-1. Outdoor Unit	24
6. REFRIGERANT R32	25
6-1. Safety During Installation/Serviceing	25
6-2. Refrigerant Piping Installation	25
6-2-1. Piping Materials and Joints Used	25
6-2-2. Processing of Piping Materials	26
6-3. Tools	29
6-3-1. Required Tools	29
6-4. Recharging of Refrigerant	29
6-5. Brazing of Pipes	30
6-5-1. Materials for Brazing	30
6-5-2. Flux	30
6-5-3. Brazing.....	31
6-6. Instructions for Re-use Piping of R22 or R407C	32
6-6-1. Basic Conditions Needed to Reuse the Existing Pipe	32
6-6-2. Restricted Items to Use the Existing Pipes.....	32
6-6-3. Branching Pipe for Simultaneous Operation System	32
6-6-4. Curing of Pipes	32
6-6-5. Final Installation Checks.....	33
6-6-6. Handling of Existing Pipe	34
6-6-7. Recovering Refrigerant	34
6-7. Charging additional refrigerant	34
6-7-1. [Assumed gas leak]	34
6-7-2. [Limiting the additional charge]	34
6-7-3. [Cautions on charging additional refrigerant]	34
6-8. General safety precautions for using R32 refrigerant	35
6-8-1. Recovery.....	35
6-8-2. Decommissioning	35
6-8-3. Labelling	35
7. CIRCUIT CONFIGURATION AND CONTROL SPECIFICATIONS .	36
7-1. Outdoor Unit Control	36
7-1-1. Print Circuit Board, MCC-1596 (Compressor IPDU)	36
7-1-2. Print Circuit Board, MCC-1597 (Fan Motor IPDU)	37
7-1-3. Print Circuit Board, MCC-1599 (Interface (CDB))	38
7-1-4. Print Circuit Board, MCC-1600 (Noise Filter)	39
7-2. Outline of Main Controls	40

8. TROUBLESHOOTING	45
8-1. Summary of Troubleshooting	45
8-2. Diagnostic Procedure for Each Check Code (Outdoor Unit)	57
8-3. Sensor characteristics	68
9. SETUP AT LOCAL SITE AND OTHERS	70
9-1. Calling of check Code History	70
9-2. Group Control Operation	70
9-3. Outdoor Unit	72
10. ADDRESS SETUP	79
10-1. Address Setup Procedure	79
10-2. Address Setup & Group Control	80
10-2-1. System Configuration	81
10-2-2. Automatic Address Example from Unset Address (No miss-wiring)	82
10-3. Remote Controller Wiring	83
10-4. Address Setup (Manual setting from remote controller)	84
10-5. Confirmation of Indoor Unit No. Position	85
11. REPLACEMENT OF THE SERVICE P.C. BOARD MCC-1599 ...	87
12. HOW TO EXCHANGE COMPRESSOR	88
12-1. Exchanging Procedure of Compressor (Outline)	88
12-2. Exchange of Compressor	88
13. DETACHMENTS	89
13-1. Outdoor Unit	89
14. EXPLODED VIEWS AND PARTS LIST	101
14-1. Outdoor Unit	101
14-2. Inverter Assembly	107

Original instruction

Please read carefully through these instructions including important information which complies with the “Machinery Directive” (Directive 2006/42/EC), and ensure that you understand them.

Some of the details provided in these instructions differ from the service manual, and the instructions provided here take precedence.

Generic Denomination: Air Conditioner

Definition of Qualified Installer or Qualified Service Person

The air conditioner must be installed, maintained, repaired and removed by a qualified installer or qualified service person.

When any of these jobs is to be done, ask a qualified installer or qualified service person to do them for you.

A qualified installer or qualified service person is an agent who has the qualifications and knowledge described in the table below.

Agent	Qualifications and knowledge which the agent must have
Qualified installer (*1)	<ul style="list-style-type: none">• The qualified installer is a person who installs, maintains, relocates and removes the air conditioners made by Toshiba Carrier Corporation. He or she has been trained to install, maintain, relocate and remove the air conditioners made by Toshiba Carrier Corporation or, alternatively, he or she has been instructed in such operations by an individual or individuals who have been trained and is thus thoroughly acquainted with the knowledge related to these operations.• The qualified installer who is allowed to do the electrical work involved in installation, relocation and removal has the qualifications pertaining to this electrical work as stipulated by the local laws and regulations, and he or she is a person who has been trained in matters relating to electrical work on the air conditioners made by Toshiba Carrier Corporation or, alternatively, he or she has been instructed in such matters by an individual or individuals who have been trained and is thus thoroughly acquainted with the knowledge related to this work.• The qualified installer who is allowed to do the refrigerant handling and piping work involved in installation, relocation and removal has the qualifications pertaining to this refrigerant handling and piping work as stipulated by the local laws and regulations, and he or she is a person who has been trained in matters relating to refrigerant handling and piping work on the air conditioners made by Toshiba Carrier Corporation or, alternatively, he or she has been instructed in such matters by an individual or individuals who have been trained and is thus thoroughly acquainted with the knowledge related to this work.• The qualified installer that is allowed to work at heights has been trained in matters relating to working at heights with the air conditioners made by Toshiba Carrier Corporation or, alternatively, he or she has been instructed in such matters by an individual or individuals who have been trained and is thus thoroughly acquainted with the knowledge related to this work.
Qualified service person (*1)	<ul style="list-style-type: none">• The qualified service person is a person who installs, repairs, maintains, relocates and removes the air conditioners made by Toshiba Carrier Corporation. He or she has been trained to install, repair, maintain, relocate and remove the air conditioners made by Toshiba Carrier Corporation or, alternatively, he or she has been instructed in such operations by an individual or individuals who have been trained and is thus thoroughly acquainted with the knowledge related to these operations.• The qualified service person who is allowed to do the electrical work involved in installation, repair, relocation and removal has the qualifications pertaining to this electrical work as stipulated by the local laws and regulations, and he or she is a person who has been trained in matters relating to electrical work on the air conditioners made by Toshiba Carrier Corporation or, alternatively, he or she has been instructed in such matters by an individual or individuals who have been trained and is thus thoroughly acquainted with the knowledge related to this work.• The qualified service person who is allowed to do the refrigerant handling and piping work involved in installation, repair, relocation and removal has the qualifications pertaining to this refrigerant handling and piping work as stipulated by the local laws and regulations, and he or she is a person who has been trained in matters relating to refrigerant handling and piping work on the air conditioners made by Toshiba Carrier Corporation or, alternatively, he or she has been instructed in such matters by an individual or individuals who have been trained and is thus thoroughly acquainted with the knowledge related to this work.• The qualified service person who is allowed to work at heights has been trained in matters relating to working at heights with the air conditioners made by Toshiba Carrier Corporation or, alternatively, he or she has been instructed in such matters by an individual or individuals who have been trained and is thus thoroughly acquainted with the knowledge related to this work.

Definition of Protective Gear

When the air conditioner is to be transported, installed, maintained, repaired or removed, wear protective gloves and 'safety' work clothing.



In addition to such normal protective gear, wear the protective gear described below when undertaking the special work detailed in the table below.

Failure to wear the proper protective gear is dangerous because you will be more susceptible to injury, burns, electric shocks and other injuries.

Work undertaken	Protective gear worn
All types of work	Protective gloves "Safety" working clothing
Electrical-related work	Gloves to provide protection for electricians Insulating shoes Clothing to provide protection from electric shock
Work done at heights (50 cm or more)	Helmets for use in industry
Transportation of heavy objects	Shoes with additional protective toecap
Repair of outdoor unit	Gloves to provide protection for electricians



The important contents concerned to the safety are described on the product itself and on this Service Manual. Please read this Service Manual after understanding the described items thoroughly in the following contents (Indications/Illustrated marks), and keep them.

[Explanation of indications]

Indication	Explanation
 DANGER	Indicates contents assumed that an imminent danger causing a death or serious injury of the repair engineers and the third parties when an incorrect work has been executed.
 WARNING	Indicates possibilities assumed that a danger causing a death or serious injury of the repair engineers, the third parties, and the users due to troubles of the product after work when an incorrect work has been executed.
 CAUTION	Indicates contents assumed that an injury or property damage (*) may be caused on the repair engineers, the third parties, and the users due to troubles of the product after work when an incorrect work has been executed.

* Property damage : Enlarged damage concerned to property, furniture, and domestic animal/pet

[Explanation of illustrated marks]





Mark	Explanation
	Indicates prohibited items (Forbidden items to do) The sentences near an illustrated mark describe the concrete prohibited contents.
	Indicates mandatory items (Compulsory items to do) The sentences near an illustrated mark describe the concrete mandatory contents.
	Indicates cautions (Including danger/warning) The sentences or illustration near or in an illustrated mark describe the concrete cautious contents.

Warning Indications on the Air Conditioner Unit

[Confirmation of warning label on the main unit]

Confirm that labels are indicated on the specified positions.



If removing the label during parts replace, stick it as the original.

Warning indication	Description				
 <table border="1" data-bbox="172 461 823 701"> <tr> <td data-bbox="172 461 308 551"></td> <td data-bbox="308 461 823 551">WARNING</td> </tr> <tr> <td data-bbox="172 551 308 701"></td> <td data-bbox="308 551 823 701"> ELECTRICAL SHOCK HAZARD Disconnect all remote electric power supplies before servicing. </td> </tr> </table>		WARNING		ELECTRICAL SHOCK HAZARD Disconnect all remote electric power supplies before servicing.	WARNING ELECTRICAL SHOCK HAZARD Disconnect all remote electric power supplies before servicing.
	WARNING				
	ELECTRICAL SHOCK HAZARD Disconnect all remote electric power supplies before servicing.				
 <table border="1" data-bbox="172 815 823 1032"> <tr> <td data-bbox="172 815 308 904"></td> <td data-bbox="308 815 823 904">WARNING</td> </tr> <tr> <td data-bbox="172 904 308 1032"></td> <td data-bbox="308 904 823 1032"> Moving parts. Do not operate unit with grille removed. Stop the unit before the servicing. </td> </tr> </table>		WARNING		Moving parts. Do not operate unit with grille removed. Stop the unit before the servicing.	WARNING Moving parts. Do not operate unit with grille removed. Stop the unit before the servicing.
	WARNING				
	Moving parts. Do not operate unit with grille removed. Stop the unit before the servicing.				
 <table border="1" data-bbox="172 1155 823 1373"> <tr> <td data-bbox="172 1155 308 1245"></td> <td data-bbox="308 1155 823 1245">CAUTION</td> </tr> <tr> <td data-bbox="172 1245 308 1373"></td> <td data-bbox="308 1245 823 1373"> High temperature parts. You might get burned when removing this panel. </td> </tr> </table>		CAUTION		High temperature parts. You might get burned when removing this panel.	CAUTION High temperature parts. You might get burned when removing this panel.
	CAUTION				
	High temperature parts. You might get burned when removing this panel.				
 <table border="1" data-bbox="172 1476 823 1666"> <tr> <td data-bbox="172 1476 308 1565"></td> <td data-bbox="308 1476 823 1565">CAUTION</td> </tr> <tr> <td data-bbox="172 1565 308 1666"></td> <td data-bbox="308 1565 823 1666"> Do not touch the aluminum fins of the unit. Doing so may result in injury. </td> </tr> </table>		CAUTION		Do not touch the aluminum fins of the unit. Doing so may result in injury.	CAUTION Do not touch the aluminum fins of the unit. Doing so may result in injury.
	CAUTION				
	Do not touch the aluminum fins of the unit. Doing so may result in injury.				
 <table border="1" data-bbox="172 1783 823 2040"> <tr> <td data-bbox="172 1783 308 1872"></td> <td data-bbox="308 1783 823 1872">CAUTION</td> </tr> <tr> <td data-bbox="172 1872 308 2040"></td> <td data-bbox="308 1872 823 2040"> BURST HAZARD Open the service valves before the operation, otherwise there might be the burst. </td> </tr> </table>		CAUTION		BURST HAZARD Open the service valves before the operation, otherwise there might be the burst.	CAUTION BURST HAZARD Open the service valves before the operation, otherwise there might be the burst.
	CAUTION				
	BURST HAZARD Open the service valves before the operation, otherwise there might be the burst.				

Precaution for Safety





The appliance shall be installed in accordance with national wiring regulations. Capacity shortages of the power circuit or an incomplete installation may cause an electric shock or fire.

DANGER

 Turn off breaker.	<p>Before carrying out the installation, maintenance, repair or removal work, be sure to set the circuit breaker to the OFF position. Otherwise, electric shocks may result.</p>
	<p>Before opening the intake grille of the indoor unit or service panel of the outdoor unit, set the circuit breaker to the OFF position. Failure to set the circuit breaker to the OFF position may result in electric shocks through contact with the interior parts. Only a qualified installer (*1) or qualified service person (*1) is allowed to remove the intake grille of the indoor unit or service panel of the outdoor unit and do the work required.</p>
	<p>Before starting to repair the outdoor unit fan or fan guard, be absolutely sure to set the circuit breaker to the OFF position, and place a "Work in progress" sign on the circuit breaker.</p>
	<p>When cleaning the filter or other parts of the indoor unit, set the circuit breaker to OFF without fail, and place a "Work in progress" sign near the circuit breaker before proceeding with the work.</p>
 Prohibition	<p>Do not turn ON the circuit breaker under the condition of removing a cabinet, a panel, etc. Otherwise, it leads to an electric shock with a high voltage, resulting in loss of life.</p>







(*1) Refer to the "Definition of Qualified Installer or Qualified Service Person."





WARNING





 General	<p>Before starting to repair the air conditioner, read carefully through the Service Manual, and repair the air conditioner by following its instructions.</p>
	<p>Only qualified service person (*1) is allowed to repair the air conditioner. Repair of the air conditioner by unqualified person may give rise to a fire, electric shocks, injury, water leaks and/or other problems.</p>
	<p>Only a qualified installer (*1) or qualified service person (*1) is allowed to carry out the electrical work of the air conditioner. Under no circumstances must this work be done by an unqualified individual since failure to carry out the work properly may result in electric shocks and/or electrical leaks.</p>
	<p>Wear protective gloves and safety work clothing during installation, servicing and removal.</p>
	<p>When connecting the electrical wires, repairing the electrical parts or undertaking other electrical jobs, wear gloves to provide protection for electricians, insulating shoes and clothing to provide protection from electric shocks. Failure to wear this protective gear may result in electric shocks.</p>
	<p>Use wiring that meets the specifications in the Installation Manual and the stipulations in the local regulations and laws. Use of wiring which does not meet the specifications may give rise to electric shocks, electrical leakage, smoking and/or a fire.</p>
	<p>Only a qualified installer (*1) or qualified service person (*1) is allowed to undertake work at heights using a stand of 50 cm or more.</p>
	<p>When working at heights, use a ladder which complies with the ISO 14122 standard, and follow the procedure in the ladder's instructions. Also wear a helmet for use in industry as protective gear to undertake the work.</p>
	<p>When working at heights, put a sign in place so that no-one will approach the work location, before proceeding with the work. Parts and other objects may fall from above, possibly injuring a person below.</p>
	<p>Do not touch the aluminum fin of the outdoor unit. You may injure yourself if you do so. If the fin must be touched for some reason, first put on protective gloves and safety work clothing, and then proceed.</p>
	<p>Do not climb onto or place objects on top of the outdoor unit. You may fall or the objects may fall off the outdoor unit and result in injury.</p>
	<p>When transporting the air conditioner, wear shoes with additional protective toecap.</p>
	<p>When transporting the air conditioner, do not hold the bands around the packing carton. You may injure yourself if the bands should break.</p>
<p>This air conditioner has passed the pressure test as specified in IEC 60335-2-40 Annex EE.</p>	
 Electric shock hazard	<p>When you access inside of the electric cover to repair electric parts, wait for about five minutes after turning off the breaker. Do not start repairing immediately. Otherwise you may get electric shock by touching terminals of high-voltage capacitors. Natural discharge of the capacitor takes about five minutes.</p>
 Prohibition	<p>Place a "Work in progress" sign near the circuit breaker while the installation, maintenance, repair, or removal work is being carried out. There is a danger of electric shocks if the circuit breaker is set to ON by mistake.</p>
	<p>When checking the electric parts, removing the cover of the electric parts box of Indoor Unit and/or front panel of Outdoor Unit inevitably to determine the failure, put a sign "Do not enter" around the site before the work. Failure to do this may result in third person getting electric shock.</p>
 Stay on protection	<p>Before operating the air conditioner after having completed the work, check that the electrical parts box cover of the indoor unit and service panel of the outdoor unit are closed, and set the circuit breaker to the ON position. You may receive an electric shock if the power is turned on without first conducting these checks.</p>
 Stay on protection	<p>If, in the course of carrying out repairs, it becomes absolutely necessary to check out the electrical parts with the electrical parts box cover of one or more of the indoor units and the service panel of the outdoor unit removed in order to find out exactly where the trouble lies, wear insulated heat-resistant gloves, insulated boots and insulated work overalls, and take care to avoid touching any live parts. You may receive an electric shock if you fail to heed this warning. Only qualified service person (*1) is allowed to do this kind of work.</p>

(*1) Refer to the "Definition of Qualified Installer or Qualified Service Person."



 **WARNING**

 Check earth wires.	<p>Before troubleshooting or repair work, check the earth wire is connected to the earth terminals of the main unit, otherwise an electric shock is caused when a leak occurs. If the earth wire is not correctly connected, contact an electric engineer for rework.</p> <p>After completing the repair or relocation work, check that the earth wires are connected properly.</p> <p>Be sure to connect earth wire. (Grounding work) Incomplete earth causes an electric shock. Do not connect earth wires to gas pipes, water pipes, and lightning rods or earth wires for telephone wires.</p>
 Prohibition of modification.	<p>Do not modify the products. Do not also disassemble or modify the parts. It may cause a fire, electric shock or injury.</p>
 Use specified parts.	<p>When any of the electrical parts are to be replaced, ensure that the replacement parts satisfy the specifications given in the Service Manual (or use the parts contained on the parts list in the Service Manual). Use of any parts that do not satisfy the required specifications may give rise to electric shocks, smoking and/or a fire.</p> <p>Replace components only with parts specified by the manufacturer. Other parts may result in the ignition of refrigerant in the atmosphere due to the refrigerant leak.</p>
 Do not bring a child close to the equipment.	<p>If, in the course of carrying out repairs, it becomes absolutely necessary to check out the electrical parts with the electrical parts box cover of one or more of the indoor units and the service panel of the outdoor unit removed in order to find out exactly where the trouble lies, place "Keep out" signs around the work site before proceeding.</p> <p>Third-party individuals may enter the work site and receive electric shocks if this warning is not heeded.</p>
 Insulating measures	<p>Connect the cut-off lead wires with crimp contact, etc. put the closed end side upward and then apply a water-cut method, otherwise a leak or production of fire is caused at the users' side.</p>
 No fire	<p>When performing repairs using a gas burner, replace the refrigerant with nitrogen gas because the oil that coats the pipes may otherwise burn.</p> <p>When repairing the refrigerating cycle, take the following measures.</p> <ol style="list-style-type: none"> 1) Be attentive to fire around the cycle. When using a gas stove, etc. be sure to put out fire before work; otherwise the oil mixed with refrigerant gas may catch fire. 2) Do not use a brazing in the closed room. When using it without ventilation, carbon monoxide poisoning may be caused. 3) Do not bring inflammable material around to the refrigerant cycle; otherwise fire of the brazing may catch the inflammable material.

 Refrigerant	<p>The refrigerant used by this air conditioner is the R32.</p>
	<p>Check the used refrigerant name and use tools and materials of the parts, which match with it. For the products, which use R32 refrigerant, the refrigerant name is indicated at a position on the outdoor unit where is easy to see. To prevent miss charging, the route of the service port is changed from one of the former R22. Be careful for miss charging since a charging port of R32 is the same diameter as that of R410A.</p>
	<p>Do not use any refrigerant different from the one specified for complement or replacement. Otherwise, abnormally high pressure may be generated in the refrigeration cycle, which may result in a failure or explosion of the product or an injury to your body.</p>
	<p>For an air conditioner, which uses R32, never use other refrigerant than R32. For an air conditioner, which uses other refrigerant (R22, R410A etc.), never use R32. If different types of refrigerant are mixed, abnormal high pressure generates in the refrigerating cycle and an injury due to breakage may be caused. If the different type of refrigerants are mixed in, be sure to recharge the refrigerant</p>
	<p>Do not charge refrigerant additionally. If charging refrigerant additionally when refrigerant gas leaks, the refrigerant composition in the refrigerating cycle changes resulted in change of air conditioner characteristics or refrigerant over the specified standard amount is charged and an abnormal high pressure is applied to the inside of the refrigerating cycle resulted in cause of breakage or injury. Therefore if the refrigerant gas leaks, recover the refrigerant in the air conditioner, execute vacuuming, and then newly recharge the specified amount of liquid refrigerant. In this time, never charge the refrigerant over the specified amount.</p>
	<p>When recharging the refrigerant in the refrigerating cycle, do not mix the refrigerant or air other than R32 into the specified refrigerant. If air or others is mixed with the refrigerant, abnormal high pressure generates in the refrigerating cycle resulted in cause of injury due to breakage.</p>
	<p>After the installation work, confirm that refrigerant gas does not leak. If refrigerant gas leaks into the room and flows near a fire source, such as a cooking range, noxious gas may be generated.</p>
	<p>Never recover the refrigerant into the outdoor unit. When the equipment is moved or repaired, be sure to recover the refrigerant with recovering device. The refrigerant cannot be recovered in the outdoor unit; otherwise a serious accident such as breakage or injury is caused.</p>
 Assembly/ Cabling	<p>After repair work, surely assemble the disassembled parts, and connect and lead the removed wires as before. Perform the work so that the cabinet or panel does not catch the inner wires. If incorrect assembly or incorrect wire connection was done, a disaster such as a leak or fire is caused at user's side.</p>
 Insulator check	<p>After the work has finished, be sure to use an insulation tester set (500V MΩ) to check the resistance is 1MΩ or more between the charge section and the non-charge metal section (Earth position). If the resistance value is low, a disaster such as a leak or electric shock is caused at user's side.</p>
 Ventilation	<p>When the refrigerant gas leaks during work, execute ventilation. If the refrigerant gas touches to a fire, it may generate noxious gases, causing a fire. A case of leakage of the refrigerant and the closed room full with gas is dangerous because a shortage of oxygen occurs. Be sure to execute ventilation.</p> <p>If refrigerant gas has leaked during the installation work, ventilate the room immediately. If the leaked refrigerant gas comes in contact with fire, it may generate noxious gases, causing a fire.</p>



 Compulsion	<p>When the refrigerant gas leaks, find out the leaked position and repair it surely. If the leaked position cannot be found out and the repair work is interrupted, pump-down and tighten the service valve, otherwise the refrigerant gas may leak into the room. When gas touches to fire such as fan heater, stove or cooking stove, it may generate noxious gases, causing a fire though the refrigerant gas itself is innocuous. When installing equipment, which includes a large amount of charged refrigerant such as a multi air conditioner in a sub-room, it is necessary that the density does not the limit even if the refrigerant leaks. If the refrigerant leaks and exceeds the limit density, an accident of shortage of oxygen is caused.</p> <p>Tighten the flare nut with a torque wrench in the specified manner. Excessive tighten of the flare nut may cause a crack in the flare nut after a long period, which may result in refrigerant leakage.</p> <p>Nitrogen gas must be used for the airtight test.</p> <p>The charge hose must be connected in such a way that it is not slack.</p> <p>For the installation/moving/reinstallation work, follow to the Installation Manual. If an incorrect installation is done, a trouble of the refrigerating cycle, water leak, electric shock or fire is caused.</p> <p>Install the outdoor unit properly in a location that is durable enough to support the weight of the outdoor unit. Insufficient durability may cause the outdoor unit to fall, which may result in injury.</p>
 Check after repair	<p>Once the repair work has been completed, check for refrigerant leaks, and check the insulation resistance and water drainage. Then perform a trial run to check that the air conditioner is running properly.</p> <p>After repair work has finished, check there is no trouble. If check is not executed, a fire, electric shock or injury may be caused. For a check, turn off the power breaker.</p> <p>After repair work (installation of front panel and cabinet) has finished, execute a test run to check there is no generation of smoke or abnormal sound. If check is not executed, a fire or an electric shock is caused. Before test run, install the front panel and cabinet.</p>
 Do not operate the unit with the valve closed.	<p>Check the following matters before a test run after repairing piping.</p> <ul style="list-style-type: none"> • Connect the pipes surely and there is no leak of refrigerant. • The valve is opened. <p>Running the compressor under condition that the valve closes causes an abnormal high pressure resulted in damage of the parts of the compressor and etc. and moreover if there is leak of refrigerant at connecting section of pipes, the air is suctioned and causes further abnormal high pressure resulted in burst or injury.</p>
 Check after reinstallation	<p>Only a qualified installer (*1) or qualified service person (*1) is allowed to relocate the air conditioner. It is dangerous for the air conditioner to be relocated by an unqualified individual since a fire, electric shocks, injury, water leakage, noise and/or vibration may result.</p> <p>Check the following items after reinstallation.</p> <ol style="list-style-type: none"> 1) The earth wire is correctly connected. 2) The power cord is not caught in the product. 3) There is no inclination or unsteadiness and the installation is stable. <p>If check is not executed, a fire, an electric shock or an injury is caused.</p>
 Cooling check	<p>When the service panel of the outdoor unit is to be opened in order for the compressor or the area around this part to be repaired immediately after the air conditioner has been shut down, set the circuit breaker to the OFF position, and then wait at least 10 minutes before opening the service panel. If you fail to heed this warning, you will run the risk of burning yourself because the compressor pipes and other parts will be very hot to the touch. In addition, before proceeding with the repair work, wear the kind of insulated heat-resistant gloves designed to protect electricians.</p> <p>When the service panel of the outdoor unit is to be opened in order for the fan motor, reactor, inverter or the areas around these parts to be repaired immediately after the air conditioner has been shut down, set the circuit breaker to the OFF position, and then wait at least 10 minutes before opening the service panel. If you fail to heed this warning, you will run the risk of burning yourself because the fan motor, reactor, inverter heat sink and other parts will be very hot to the touch. In addition, before proceeding with the repair work, wear the kind of insulated heat-resistant gloves designed to protect electricians.</p>

(*1) Refer to the “Definition of Qualified Installer or Qualified Service Person.”

 Installation	Only a qualified installer (*1) or qualified service person (*1) is allowed to install the air conditioner. If the air conditioner is installed by an unqualified individual, a fire, electric shocks, injury, water leakage, noise and/or vibration may result.
	Before starting to install the air conditioner, read carefully through the Installation Manual, and follow its instructions to install the air conditioner.
	Do not install the air conditioner in a location that may be subject to a risk of exposing to a combustible gas. If a combustible gas leaks and becomes concentrated around the unit, a fire may occur.
	When transporting the air conditioner, use a forklift and when moving the air conditioner by hand, move the unit with 4 people.
	Install a circuit breaker that meets the specifications in the Installation Manual and the stipulations in the local regulations and laws.
	Install the circuit breaker where it can be easily accessed by the agent.
	Do not place any combustion appliance in a place where it is directly exposed to the wind of air conditioner, otherwise it may cause imperfect combustion.
 Compulsion	When carrying out the pump-down work shut down the compressor before disconnecting the refrigerant pipe. Disconnecting the refrigerant pipe with the service valve left open and the compressor still operating will cause air, etc. to be sucked in, raising the pressure inside the refrigeration cycle to an abnormally high level, and possibly resulting in rupture, injury, etc.
	When removing the brazing parts of suction and discharge pipe for the compressor, remove them at the place ventilated well after recovering the refrigerant. Improper recovering may cause the spurt of the refrigerant and the refrigeration oil, causing an injury.
 Prohibition	Do not vent gases to the atmosphere. Venting gases to the atmosphere is prohibited by the law.

(*1) Refer to the “Definition of Qualified Installer or Qualified Service Person.”

CAUTION

 Wearing of gloves	Ensure wearing of gloves when performing any work in order to avoid injury from parts, etc. Failure to wear the proper protective gloves cause an injury due to the parts, etc.
 Confirm	When performing the brazing work, check whether refrigerant leaks or remains. If the leakage refrigerant gas touches a fire source, it may generate noxious gases, causing a fire.

Explanations given to user

- If you have discovered that the fan grille is damaged, do not approach the outdoor unit but set the circuit breaker to the OFF position, and contact a qualified service person to have the repairs done.
Do not set the circuit breaker to the ON position until the repairs are completed.

Relocation

- Only a qualified installer (*1) or qualified service person (*1) is allowed to relocate the air conditioner. It is dangerous for the air conditioner to be relocated by an unqualified individual since a fire, electric shocks, injury, water leakage, noise and/or vibration may result.
- When carrying out the pump-down work shut down the compressor before disconnecting the refrigerant pipe.
Disconnecting the refrigerant pipe with the service valve left open and the compressor still operating will cause air, etc. to be sucked in, raising the pressure inside the refrigeration cycle to an abnormally high level, and possibly resulting in rupture, injury, etc.

(*1) Refer to the “Definition of Qualified Installer or Qualified Service Person.”

Declaration of Conformity

Manufacturer: TOSHIBA CARRIER CORPORATION
336 Tadehara, Fuji-shi, Shizuoka-ken 416-8521 JAPAN

TCF holder: TOSHIBA CARRIER EUROPE S.A.S
Route de Thil
01120 Montluel FRANCE

Hereby declares that the machinery described below:

Generic Denomination: Air Conditioner

Model/type: RAV-GP1101AT8-E, RAV-GP1401AT8-E, RAV-GP1601AT8-E
RAV-GP1101AT8J-E, RAV-GP1401AT8J-E, RAV-GP1601AT8J-E
RAV-GP1101AT8-TR, RAV-GP1401AT8-TR, RAV-GP1601AT8-TR
RAV-GP1101AT8J-TR, RAV-GP1401AT8J-TR, RAV-GP1601AT8J-TR

Commercial name: Super Digital Inverter Series Air Conditioner

Complies with the provisions of the "Machinery Directive" (Directive 2006/42/EC) and the regulations transposing into national law

Note: This declaration becomes invalid if technical or operational modifications are introduced without the manufacturer's consent.

Specifications

Model	Sound presser level (dB(A))		Weight (kg)
	Cooling	Heating	
RAV-GP1101AT8-E	*	*	95
RAV-GP1401AT8-E	*	*	95
RAV-GP1601AT8-E	*	*	95
RAV-GP1101AT8J-E	*	*	95
RAV-GP1401AT8J-E	*	*	95
RAV-GP1601AT8J-E	*	*	95
RAV-GP1101AT8-TR	*	*	95
RAV-GP1401AT8-TR	*	*	95
RAV-GP1601AT8-TR	*	*	95
RAV-GP1101AT8J-TR	*	*	95
RAV-GP1401AT8J-TR	*	*	95
RAV-GP1601AT8J-TR	*	*	95

* Under 70 dB(A)

Refrigerant R32

This air conditioner adopts a new HFC type refrigerant (R32) which does not deplete the ozone layer.

1. Safety Caution Concerned to Refrigerant R32

Be sure that water, dust, the former refrigerant or the former refrigerating oil is not mixed into the refrigerating cycle of the air conditioner with refrigerant R32 during installation work or service work. If an incorrect work or incorrect service is performed, there is a possibility to cause a serious accident. Use the tools and materials exclusive to R32 to purpose a safe work.

2. Safety and Cautions on Installation/Service

<Safety items>

When gas concentration and ignition energy are happened at the same time, R32 has a slight possibility of burning. Although it will not ignite under normal work environment conditions, be aware that the flame spreads if ignition should occur.

It is necessary to carry out installation/servicing safely while taking the following precautions into consideration.

- 1) Never use refrigerant other than specified refrigerant (R32) in an air conditioner which is designed to operate with the specified refrigerant (R32).
If other refrigerant than R32 is used, it may cause personal injury, etc. by a malfunction, a fire, a rupture.
- 2) Since R32 is heavier than air, it tends to accumulate at the bottom (near the floor).
Ventilate properly for the working environment to prevent its combustion.
Especially in a basement or a closed room where the high risk of the accumulation is ventilate the room with a local exhaust ventilator.
If refrigerant leakage is confirmed in the room or the place where the ventilation is insufficient, do not work until the proper ventilation is performed and the work environment is improved.
- 3) When performing brazing work, be sure to check for leakage refrigerant or residual refrigerant.
If the leakage refrigerant comes into contact with fire, a poisonous gas may occur or it may cause a fire.
Keep adequate ventilation during the work.
- 4) When refrigerant gas leaks during work, execute ventilation. If the leakage refrigerant comes into contact with a fire, a poisonous gas may occur or it may cause a fire.
- 5) In places where installing / repairing air-conditioning equipment, etc., keep the source of ignition such as gas combustion equipment, petroleum combustion equipment, electric heater etc. away. Do not smoke in the place.
- 6) When installing or removing an air conditioner, do not mix air in the refrigerant cycle.
If air or others is mixed with the refrigerant, abnormal high pressure generates in the refrigerating cycle, causing injury due to the breakage.
- 7) After installation work complete, confirm that refrigerant gas is not leaking on the flare connection part or others. If leaked refrigerant comes to contact with a fire, toxic gas may occur, causing a fire.
- 8) Perform the installation work and re-installation according to the installation manual.
Pay attention especially to the area of application. Improper installation may cause refrigeration trouble, water leakage, electric shock, or fire etc.
- 9) Unauthorized modifications to the air conditioner may be dangerous. If a breakdown occurs please call a qualified air conditioner technician or electrician.
Improper repair may result in water leakage, electric shock and fire, etc.
- 10) Carry out the airtight test with nitrogen at a specified pressure. Do not use oxygen or acetylene gas absolutely as it may cause an explosion.
- 11) Always carry a refrigerant leakage detection sensor during the work and work while checking that no refrigerant leaks around working environment.
- 12) If the leakage refrigerant comes into contact with fire, it may cause a fire.
Have a dry powder or CO₂ fire extinguisher adjacent to the charging area.

<Caution items>

- 1) The opposite side dimension of the air-conditioner’s flared nut using R32 and the shape of the charge port are the same as those of R410A.
- 2) Be careful not to charge refrigerant by mistake. Should the different type of refrigerant mix in, be sure to recharge the refrigerant.
- 3) Do not mix the other refrigerant or refrigerating oil with the refrigerant.
- 4) Since the pressure of R32 is 1.6 times higher than that of the former refrigerant (R22), use tools and parts for high pressure resistance specification similar to R410A.
- 5) In the installation time, use clean pipe materials and work with great attention so that water and others do not mix in because pipes are affected by impurities such as water, oxide film, oil, etc. Use the clean pipes. Be sure to braze while flowing nitrogen gas in the pipe. (Never use gas other than nitrogen gas.)
- 6) For the earth protection, use a vacuum pump for air purge.
- 7) R32 refrigerant is Single-component refrigerant that does not change its composition. Although it is possible to charge the refrigerant with either liquid or gas, charge it with liquid. (If using gas for charging, composition of the refrigerant changes and then characteristics of the air conditioner change.)

3. Pipe Materials

For the refrigerant pipes, copper pipe and joints are mainly used.
 It is necessary to select the most appropriate pipes to conform to the standard.
 Use clean pipes or joints to which little impurities adhere.

1) Copper pipe

<Piping>
 The pipe thickness, flare-finishing size, flare nut and others differ according to a refrigerant type. When using a long copper pipe for R32, it is recommended to select “Copper or copper-base pipe without seam” and one with bonded oil amount 40mg/10m or less. Also do not use crushed, deformed, discolored (especially inside) pipes. (Impurities cause clogging of expansion valves and capillary tubes.)

<Flare nut>
 Use the flare nuts which are attached to the air conditioner unit.

Be sure to select the pipes with copper thickness in the table below since the pressure of an air conditioner using R32 is higher than that of R22.

Nominal diameter	Outer diameter (mm)	Thickness (mm) R410A or R32
1/2	6.4	0.80
3/8	9.5	0.80
1/2	12.7	0.80
5/8	15.9	1.00

Make sure not to use a thin copper pipe such as 0.7 mm copper thickness in the market.

2) Joint

The flare joint and socket joint are used for joints of the copper pipe. The joints are rarely used for installation of the air conditioner. However clear impurities when using them.

4. Tools

Tools exclusive for R410A (The following tools for R410A are required.)

○: R410A tools available

△: Partly unavailable, ×: R410A tools unavailable

No.	Installation/service tools		Use	Applicability to R32 air conditioner or not	Applicability to R22 air conditioner or not
	Tools / Equipment	specification			
1	Flare tool	Clutch type	Pipe flaring	○	○
2	Copper pipe gauge for adjusting projection margin	—	Flaring by conventional flare tool	○	—
3	Torque wrench	—	Tightening of flare nut	○	×
4	Gauge manifold	Port size 1/2"-20UNF (5/16" Flare)	Evacuating, refrigerant charge, run check, etc.	○ Note 2	×
5	Charge hose	High-voltage		○	×
6	Vacuum pump	—	Vacuum drying	○ Note 3 1/2"-20UNF(5/16" Flare)	△ Connection diameter 1/4"
7	Vacuum pump adapter	—	Vacuum drying	○ Note 4 1/2"-20UNF(5/16" Flare)	△ Connection diameter 1/4"
8	Electronic balance for refrigerant charging	For 10 kg or 20 kg cylinder	Refrigerant charge	○	○
9	Leakage detector	—	Gas leakage check	○ Note 5	○ Note 5
10	Refrigerant cylinder	—	Refrigerant charge	× Note 6	×
11	Refrigerant recovery cylinder	Exclusive for R32	Refrigerant recovery container	× Note 7	×
12	Refrigerant recovery device	—	Refrigerant recovery device	○ Note 8	△ Connection diameter 1/4"

Note 1 When flaring is carried out for R410A or R32 using the conventional flare tools, adjustment of projection margin is necessary. For this adjustment, a copper pipe gauge, etc. is necessary.

Note 2 When saturation temperature is described, the gauge manifold differs for R410A and R32. If saturation temperature reading is required, special tools exclusive for R32 are required.

Note 3 Since R32 has a slight possibility of burning, be sure to use the tools corresponding to R32.

Note 4 Like R410, a Vacuum pump adapter needs installing to prevent a Vacuum pump oil (mineral oil) from flowing backward into the Charge hose. Mixing of the Vacuum pump oil into R32 refrigerant may cause a trouble such as generation of sludge, clogging of capillary, etc.

Note 5 Be sure to use those tools after confirming they correspond to each refrigerant.

Note 6 For a refrigerant cylinder exclusive for R32, the paint color (or label color) of the cylinder is set to the specified color (light blue) together with the indication of the refrigerant name.

Note 7 Although the container specification is the same as R410A, use a recovering container exclusive for R32 to avoid mixing with other refrigerants.

Note 8 Be careful for miss charging of the refrigerant during work. Miss charging of the refrigerant type may cause not only damage of the equipment but also a fire etc.

General tools

In addition to the above exclusive tools, the following equipment is necessary as the general tools.

- | | |
|-----------------------|-----------------------------|
| 1) Pipe cutter | 6) Spanner or Monkey wrench |
| 2) Reamer | 7) Hole core drill |
| 3) Pipe bender | 8) Tape measure |
| 4) Level vial | 9) Metal saw |
| 5) Screwdriver (+, -) | |

Also prepare the following equipment for other installation method and run check.

- | | |
|----------------|--|
| 1) Clamp meter | 3) Insulation resistance tester (500VMΩ) |
| 2) Thermometer | 4) Electroscop |

1. SPECIFICATIONS

1-1. Outdoor Unit

Model	Outdoor unit	RAV-GP	1101AT8(J)-E 1101AT8(J)-TR	1401AT8(J)-E 1401AT8(J)-TR	1601AT8(J)-E 1601AT8(J)-TR
Power supply			3 phase 380-415, 50Hz (Power exclusive to outdoor is required)		
Compressor	Type		Hermetic compressor		
	Motor	(kW)	3.75	3.75	3.75
	Pole		4	4	4
Refrigerant charged			(kg)	2.6	2.6
Refrigerant control			Pulse motor valve		
Pipe	Max	(m)	75	75	75
	Min	(m)	3	3	3
	Height	Outdoor lower	(m)	30	30
	Difference	Outdoor Height		30	30
Outer dimension	Height	(m)	1,340	1,340	1,340
	Width	(m)	900	900	900
	Depth	(m)	320	320	320
Appearance			Silky shade (Munsell 1Y8.5/0.5)		
Total weight			(kg)	95	95
Heat exchanger			Finned tube		
Fan unit	Fan		Propeller fan		
	Standard air flow	(m ³ /min)	101	103	103
	Motor	(W)	100+100	100+100	100+100
Connecting pipe (Outdoor unit side)	Gas side	(mm)	15.9	15.9	15.9
	Liquid side	(mm)	9.5	9.5	9.5
Sound pressure level	Cooling/Heating	(dB-A)	49/50	51/52	51/53
Sound power level	Cooling/Heating	(dB-A)	66/67	68/69	68/70
Outside air temperature cooling			(°C)	46 to -15°C	
Outside air temperature heating			(°C)	15 to -20°C	

1-2. Operation Characteristic Curve

- Operation characteristic curve, 50Hz <Super Digital Inverter>

<Cooling>

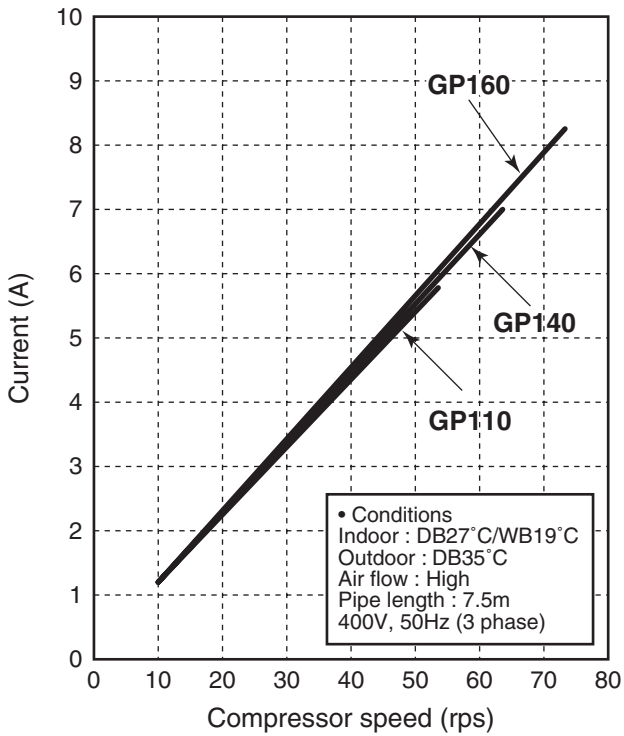

<Heating>

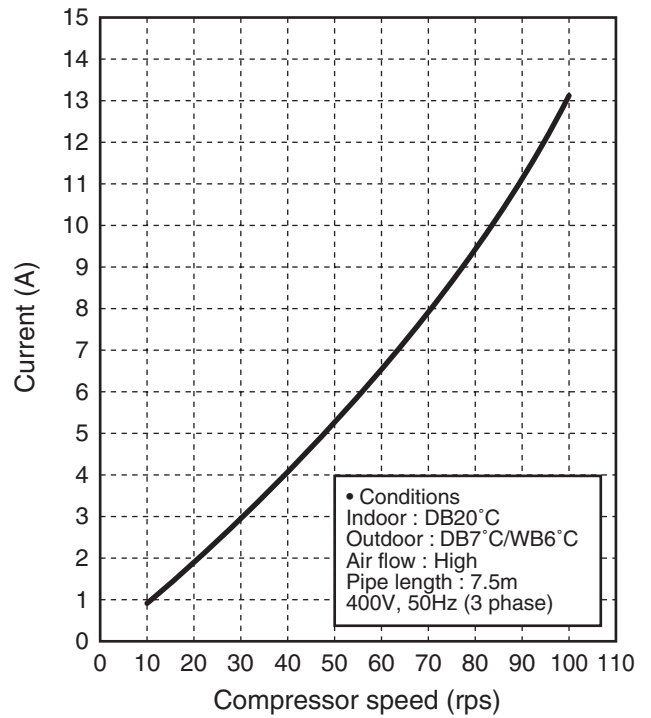

- Capacity variation ratio according to temperature

<Cooling>

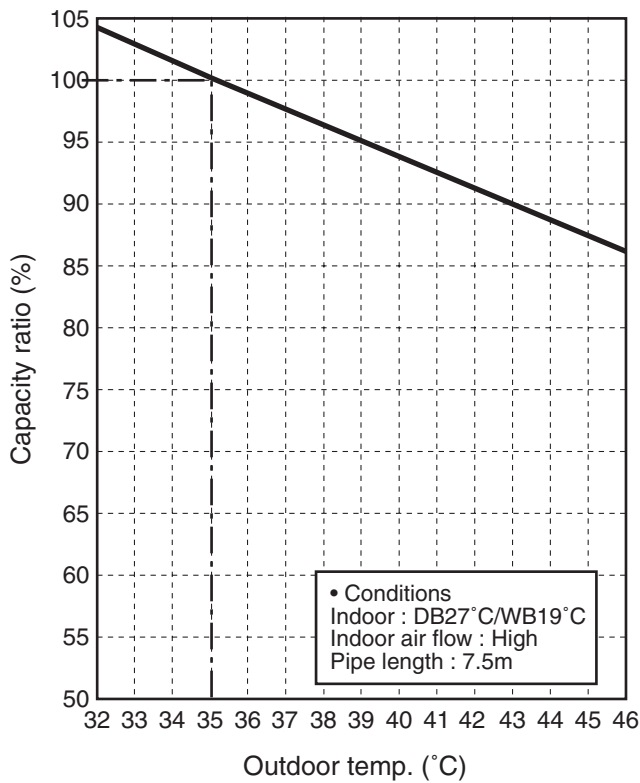

<Heating>

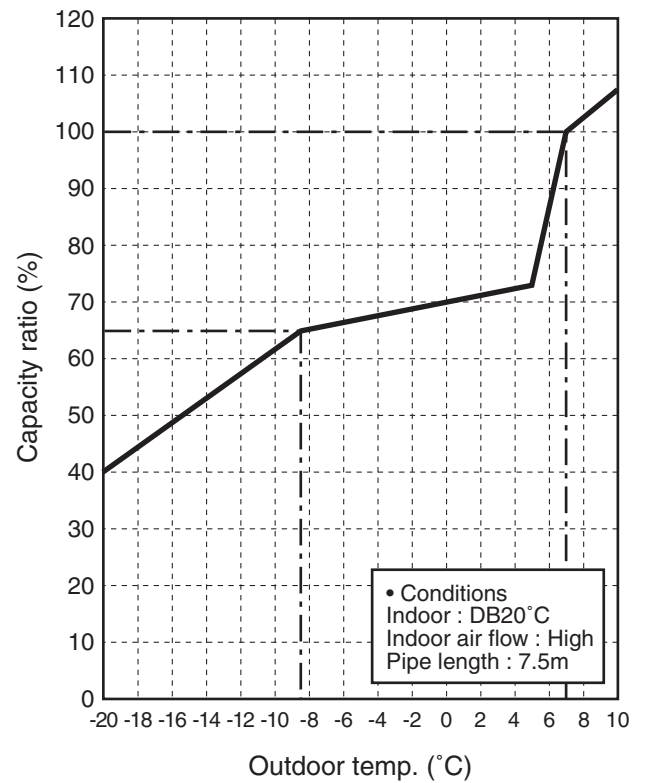

2. CONSTRUCTION VIEWS (EXTERNAL VIEWS)

2-1. Outdoor Unit

RAV-GP1101AT8(J)-E, -TR RAV-GP1401AT8(J)-E, -TR RAV-GP1601AT8(J)-E, -TR

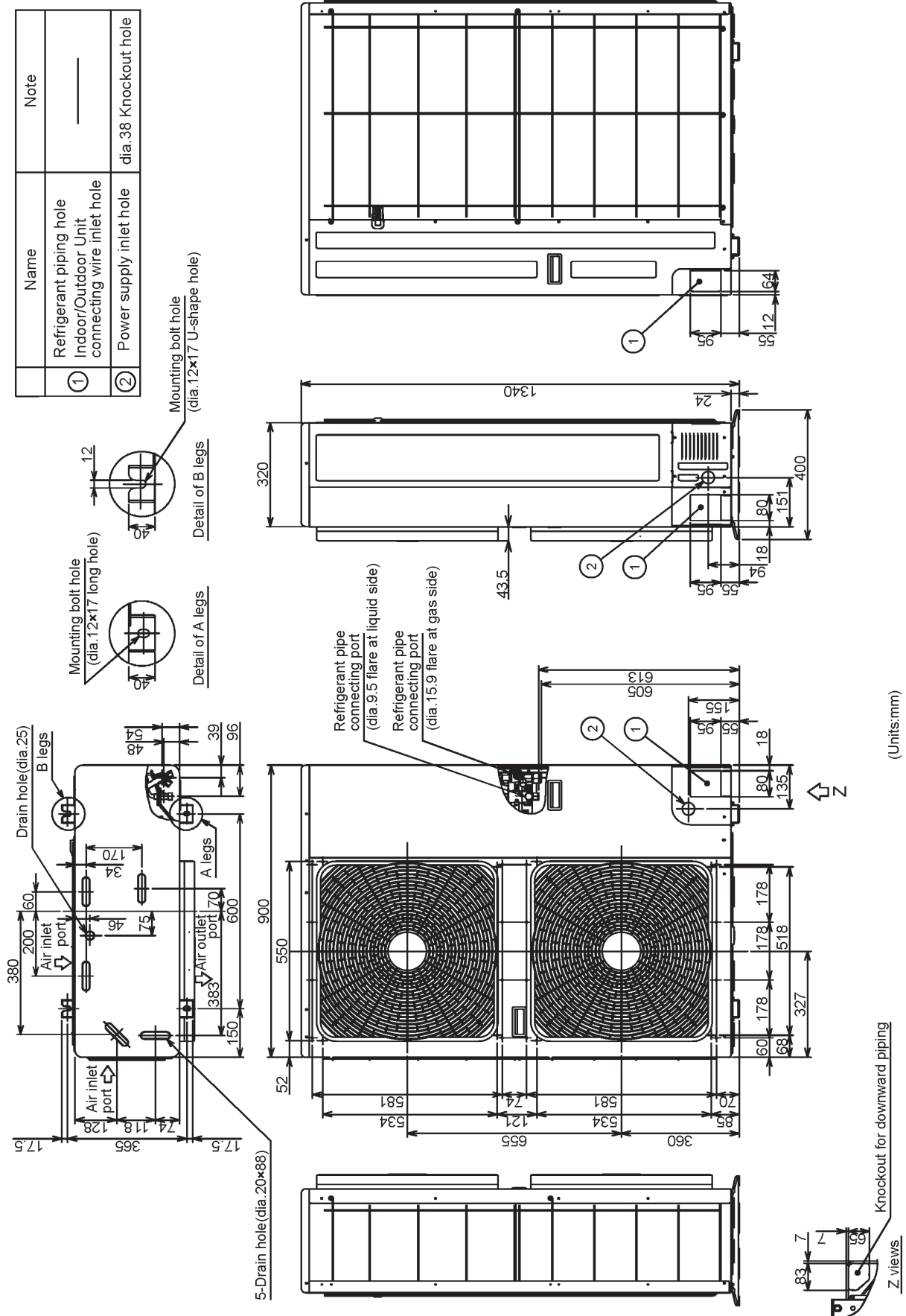

RBC-TWP30E2, RBC-TWP50E2 (Simultaneous Twin)

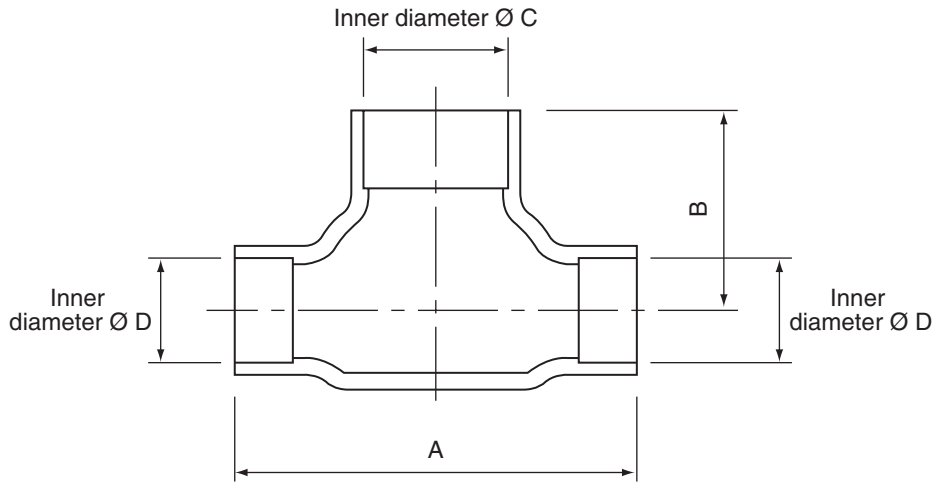

(Units: mm)

Model (RBC-)		A	B	C	D
TWP30E2	Liquid side	36	14	Ø9.5	Ø6.4
	Gas side	43	23	Ø15.9	Ø12.7
TWP50E2	Liquid side	34	14	Ø9.5	Ø9.5
	Gas side	44	21	Ø15.9	Ø15.9

RBC-TRP100E (Simultaneous Triple)

<Gas side>

Header assembly

(Units: mm)

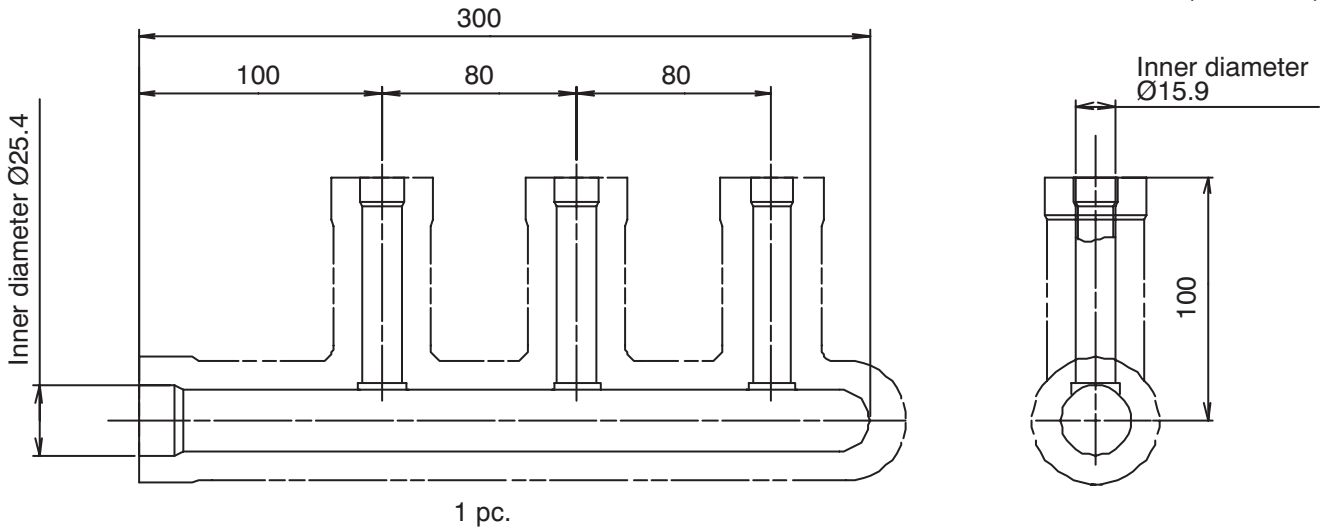

<Liquid side>

Branch pipe assembly

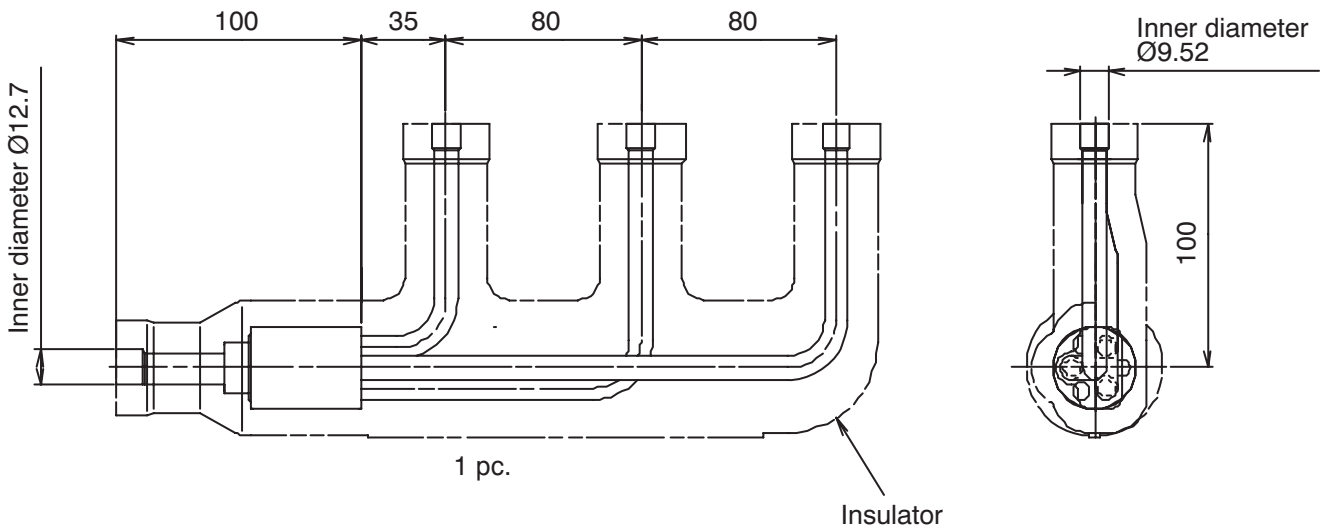

Gas side socket

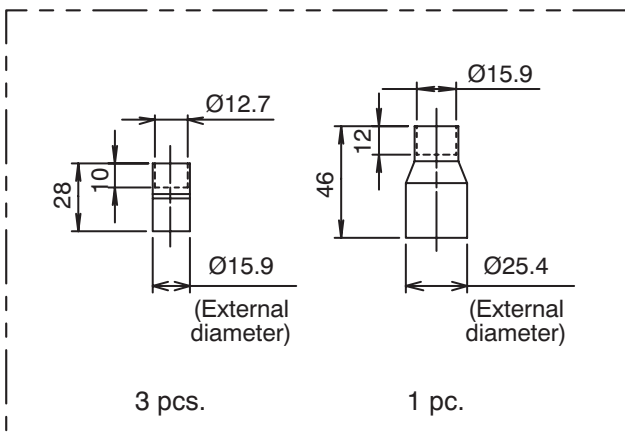

Liquid side socket

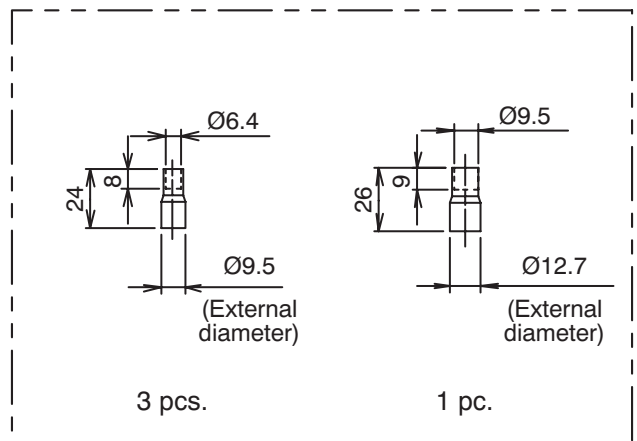

3. OUTDOOR UNIT REFRIGERATING CYCLE DIAGRAM

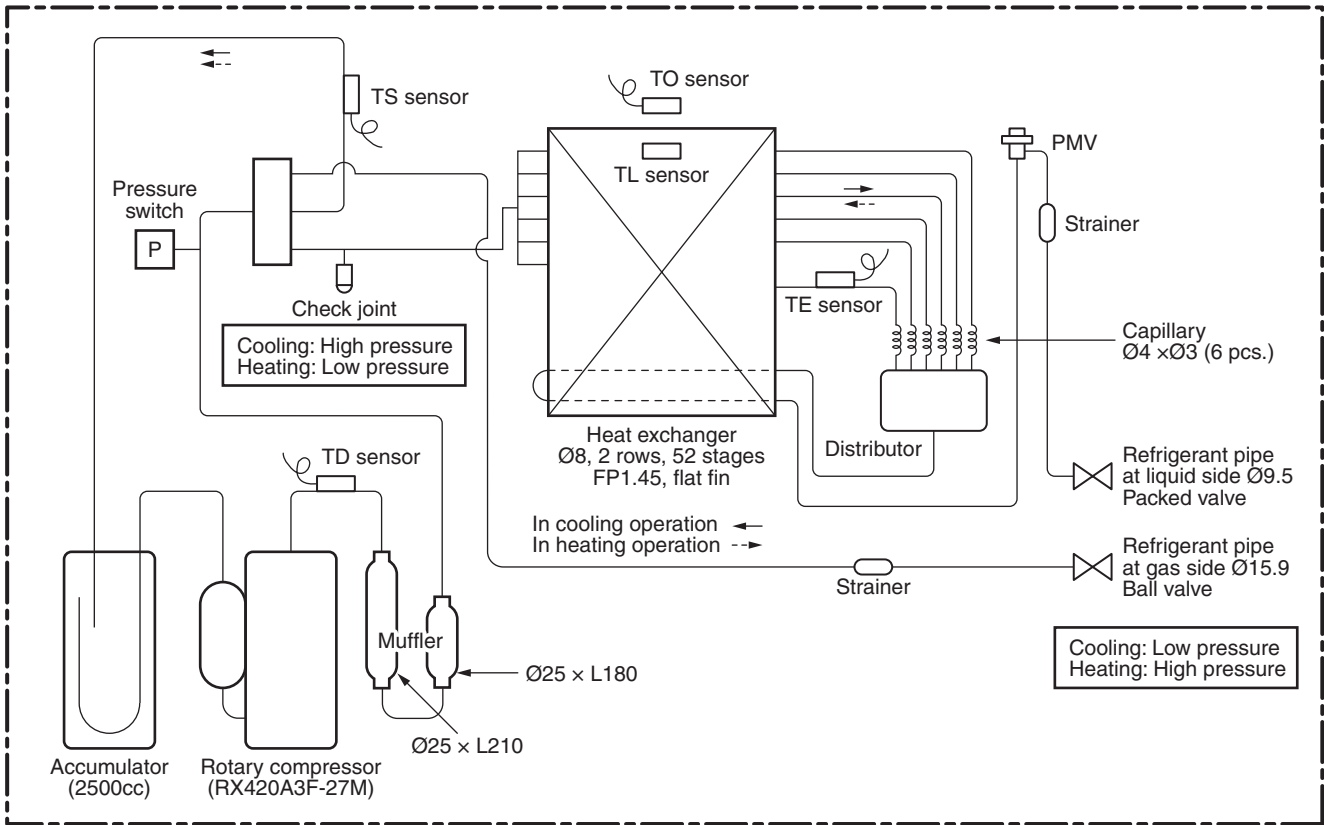

RAV-GP1101 series

		Pressure				Pipe surface temperature					Compressor drive revolution frequency (rps)	Indoor fan	Indoor/outdoor temp. condition	
		(Mpa)		(kg/cm ² G)		Discharge	Suction	Indoor heat exchanger	Outdoor heat exchanger				Indoor	Outdoor
		Pd	Ps	Pd	Ps	(TD)	(TS)	(TC)	(TL)	(TE)				
Cooling	Standard	2.3	1.1	23.5	11.7	80.2	12.9	11.0	44.6	36.9	36.6	HIGH	27/19	35/-
	Overload	3.1	1.5	32.0	14.8	67.0	17.0	16.0	48.0	47.0	35.4	HIGH	32/24	46/-
	Low load	2.2	0.7	22.6	7.4	70.0	2.0	1.0	36.0	16.0	33.0	LOW	18/15.5	-15/-
Heating	Standard	2.5	0.8	25.9	8.2	87.2	3.2	41.0	7.6	3.0	40.2	HIGH	20/-	7/6
	Overload	3.4	1.4	35.1	13.8	77.0	20.0	53.0	22.0	19.0	26.4	LOW	30/-	24/18
	Low load	2.0	0.2	20.0	1.7	78.0	-25.0	31.0	-10.0	-23.0	90.6	HIGH	15/-	-20/-

RAV-GP1401 series

		Pressure				Pipe surface temperature					Compressor drive revolution frequency (rps)	Indoor fan	Indoor/outdoor temp. condition	
		(Mpa)		(kg/cm ² G)		Discharge	Suction	Indoor heat exchanger	Outdoor heat exchanger				Indoor	Outdoor
		Pd	Ps	Pd	Ps	(TD)	(TS)	(TC)	(TL)	(TE)				
Cooling	Standard	2.4	1.0	24.0	10.6	89.7	9.3	8.0	46.8	37.6	50.4	HIGH	27/19	35/-
	Overload	3.3	1.3	34.0	13.4	73.0	18.0	17.0	51.0	50.0	42.0	HIGH	32/24	46/-
	Low load	2.2	0.7	22.7	7.5	71.0	3.0	2.0	37.0	16.0	33.0	LOW	18/15.5	-15/-
Heating	Standard	2.7	0.8	27.8	8.2	90.8	1.5	44.0	7.6	2.7	51.6	HIGH	20/-	7/6
	Overload	3.3	1.2	34.1	12.3	76.0	17.0	52.0	20.0	17.0	26.4	LOW	30/-	24/18
	Low load	1.9	0.2	19.5	1.7	77.0	-25.0	30.0	-10.0	-23.0	90.6	HIGH	15/-	-20/-

RAV-GP1601 series

		Pressure				Pipe surface temperature					Compressor drive revolution frequency (rps)	Indoor fan	Indoor/outdoor temp. condition	
		(Mpa)		(kg/cm ² G)		Discharge	Suction	Indoor heat exchanger	Outdoor heat exchanger				Indoor	Outdoor
		Pd	Ps	Pd	Ps	(TD)	(TS)	(TC)	(TL)	(TE)				
Cooling	Standard	2.4	1.0	24.1	10.3	98.6	8.7	7.0	48.4	38.3	61.2	HIGH	27/19	35/-
	Overload	3.4	1.2	35.0	12.2	77.0	19.0	18.0	54.0	53.0	48.6	HIGH	32/24	46/-
	Low load	2.2	0.8	22.7	7.6	72.0	4.0	3.0	37.0	17.0	33.0	LOW	18/15.5	-15/-
Heating	Standard	3.0	0.8	30.5	8.2	100.9	0.7	48.0	7.6	2.4	60.0	HIGH	20/-	7/6
	Overload	3.2	1.2	33.0	12.3	75.0	17.0	51.0	20.0	17.0	26.4	LOW	30/-	24/18
	Low load	1.9	0.2	19.5	1.7	77.0	-25.0	30.0	-10.0	-23.0	90.6	HIGH	15/-	-20/-

* This compressor has 4-pole motor. The value when compressor frequency (Hz) is measured by a clamp meter becomes 2 times of No. of compressor revolutions (rps).

4. WIRING DIAGRAM

4-1. Outdoor Unit

RAV-GP1101AT8(J)-E, -TR RAV-GP1401AT8(J)-E, -TR RAV-GP1601AT8(J)-E, -TR

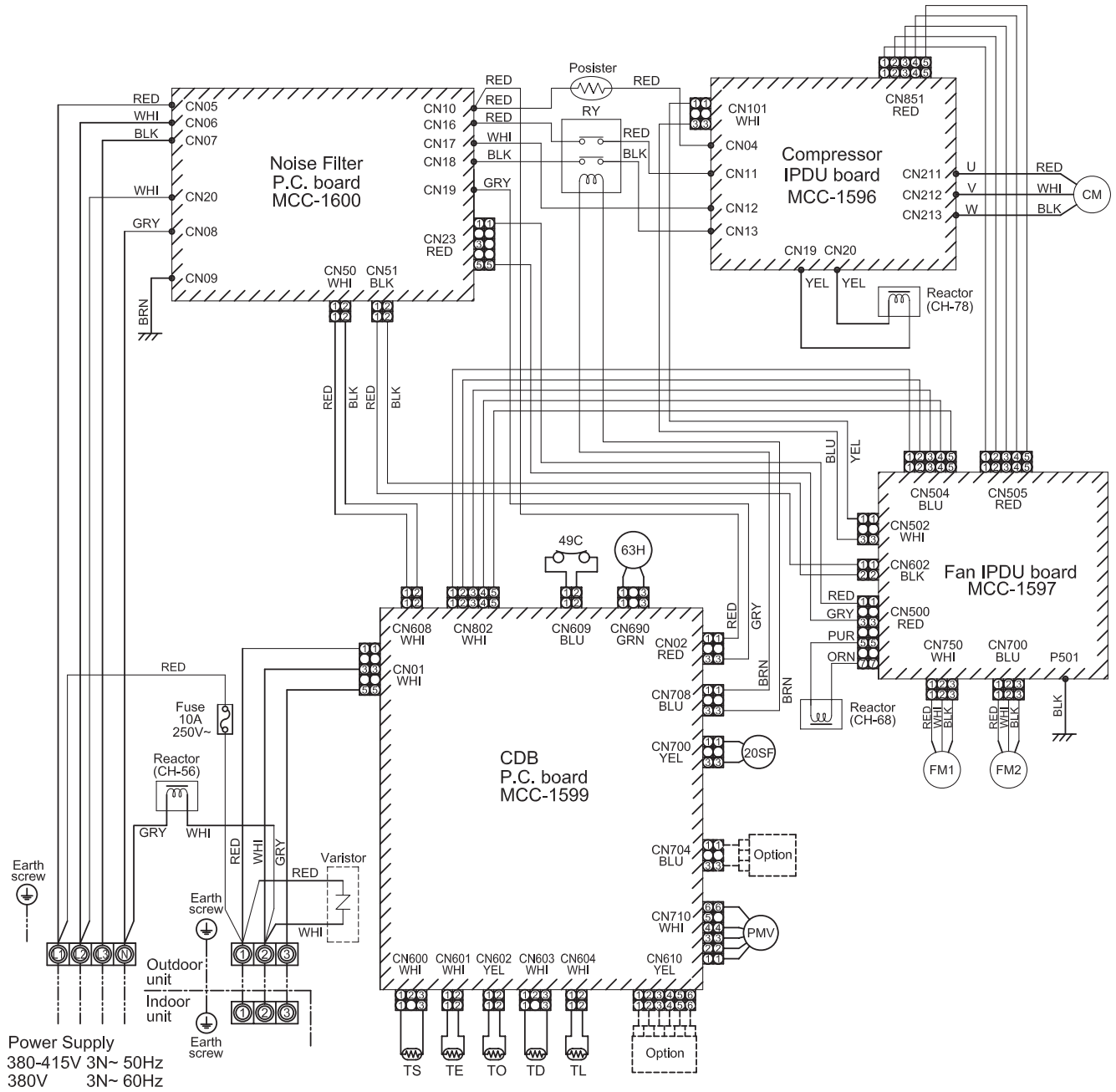

Symbol	Part name
CM	Compressor
FM1,2	Fan motor
PMV	Pulse motor valve
TD	Pipe temperature sensor (Discharge)
TS	Pipe temperature sensor (Suction)
TE	Heat exchanger sensor 1
TL	Heat exchanger sensor 2
TO	Outside temperature sensor
20SF	4-way valve coil
49C	Compressor case thermostat
63H	High-pressure switch
RY	Relay

Color Identification	
BLK : BLACK	WHI : WHITE
BLU : BLUE	BRN : BROWN
RED : RED	ORN : ORANGE
GRY : GRAY	YEL : YELLOW
GRN : GREEN	PUR : PURPLE

1. © indicates the terminal block. Alphanumeric characters in the cycle indicate the terminal No.
2. The two-dot chain line indicates the wiring procured locally.
3. ▨ indicates the P.C. board.
4. For the indoor unit circuit, refer to the wiring diagram of the indoor unit.

5. SPECIFICATIONS OF ELECTRICAL PARTS

5-1. Outdoor Unit

No.	Parts name	Type	Specifications
1	Compressor	RX420A3F-27M	—
2	Outdoor fan motor	ICF-280-A100-1	DC 280 V, 100 W
3	4-way valve coil	STF-H01AJ1736A1	AC 220 – 240 V, 50/60 Hz
4	PMV coil	UKV-A038	DC 12 V
5	High pressure switch	ACB-4UB83W	OFF : 4.15 MPa
6	Reactor	CH-78	4.2 mH, 16 A
7	Reactor	CH-68	18 mH, 5 A
8	Reactor	CH-56	5.8 mH, 18.5 A
9	P.C. board (Compressor drive)	MCC-1596	—
10	P.C. board (Fan motor drive)	MCC-1597	—
11	P.C. board (Control)	MCC-1599	—
12	P.C. board (Noise filter)	MCC-1600	—
13	Outdoor temp. sensor (TO sensor)	—	10 kΩ at 25°C
14	Discharge temp. sensor (TD sensor)	—	50 kΩ at 25°C
15	Suction temp. sensor (TS sensor)	—	10 kΩ at 25°C
16	Heat exchanger sensor (TE sensor)	—	10 kΩ at 25°C
17	Heat exchanger mid. temp. sensor (TL sensor)	—	50 kΩ at 25°C
18	Fuse	TLC 10A	10 A, 250 V
19	Fuse (Mounted on P.C. board, MCC-1596)	GAC1 31.5A	31.5 A, 500 V
20	Fuse (Mounted on P.C. board, MCC-1596)	SCT 3.15A	T3.15 A, AC 250 V
21	Fuse (Mounted on P.C. board, MCC-1597)	GDM 250V 15A	15 A, 250 V
22	Fuse (Mounted on P.C. board, MCC-1597)	SCT 3.15A	T3.15 A, AC 250 V
23	Fuse (Mounted on P.C. board, MCC-1599)	FJL 250V 3.15A	T3.15 A, AC 250 V
24	Fuse (Mounted on P.C. board, MCC-1600)	ET 6.3A	T6.3 A, AC 250 V
25	Relay	EL200/240A2-F(M)	Contact : AC 480 V, 20A
26	Posistor	ZPR0YCE 101A 500	100 Ω, 500 V
27	Compressor thermostat	US-622	OFF : 125 ± 4 °C, ON : 60 ± 5 °C

6. REFRIGERANT R32

This air conditioner adopts the R32 refrigerant which does not damage the ozone layer.

The working pressure of the new refrigerant R32 is 1.6 times higher than conventional refrigerant (R22).

The refrigerating oil is also changed in accordance with change of refrigerant, so be careful that water, dust, and existing refrigerant or refrigerating oil are not entered in the refrigerant cycle of the air conditioner using the new refrigerant during installation work or servicing time.

The next section describes the precautions for air conditioner using the new refrigerant.

Conforming to contents of the next section together with the general cautions included in this manual, perform the correct and safe work.

6-1. Safety During Installation/Serviceing

As R32's pressure is about 1.6 times higher than that of R22, improper installation/servicing may cause a serious trouble. By using tools and materials exclusive for R32, it is necessary to carry out installation/servicing safely while taking the following precautions into consideration.

1. Never use refrigerant other than R32 in an air conditioner which is designed to operate with R32. If other refrigerant than R32 is mixed, pressure in the refrigeration cycle becomes abnormally high, and it may cause personal injury, etc. by a rupture.
2. Confirm the used refrigerant name, and use tools and materials exclusive for the refrigerant R32. The refrigerant name R32 is indicated on the visible place of the outdoor unit of the air conditioner using R32 as refrigerant. A diameter of the charge port for R32 is the same as that for the R410A's. Be careful not to charge the refrigerant by mistake.
3. If a refrigeration gas leakage occurs during installation/servicing, be sure to ventilate fully. If the refrigerant gas comes into contact with fire, a poisonous gas may occur.
4. When installing or removing an air conditioner, do not allow air or moisture to remain in the refrigeration cycle. Otherwise, pressure in the refrigeration cycle may become abnormally high so that a rupture or personal injury may be caused.
5. After completion of installation work, check to make sure that there is no refrigeration gas leakage. If the refrigerant gas leaks into the room, coming into contact with fire in the fan-driven heater, space heater, etc., a poisonous gas may occur.
6. When an air conditioning system charged with a large volume of refrigerant is installed in a small room, it is necessary to exercise care so that, even when refrigerant leaks, its concentration does not exceed the marginal level. If the refrigerant gas leakage occurs and its concentration exceeds the marginal level, an oxygen starvation accident may result.

7. Be sure to carry out installation or removal according to the installation manual.

Improper installation may cause refrigeration trouble, water leakage, electric shock, fire, etc.

8. Unauthorized modifications to the air conditioner may be dangerous. If a breakdown occurs please call a qualified air conditioner technician or electrician.

Improper repair may result in water leakage, electric shock and fire, etc.

6-2. Refrigerant Piping Installation

6-2-1. Piping Materials and Joints Used

For the refrigerant piping installation, copper pipes and joints are mainly used.

Copper pipes and joints suitable for the refrigerant must be chosen and installed.

Furthermore, it is necessary to use clean copper pipes and joints whose interior surfaces are less affected by contaminants.

1. Copper Pipes

It is necessary to use seamless copper pipes which are made of either copper or copper alloy and it is desirable that the amount of residual oil is less than 40 mg/10 m.

Do not use copper pipes having a collapsed, deformed or discolored portion (especially on the interior surface).

Otherwise, the expansion valve or capillary tube may become blocked with contaminants.

As an air conditioner using R32 incurs pressure higher than when using R22, it is necessary to choose adequate materials.

Thicknesses of copper pipes used with R32 are as shown in Table 6-2-1. Never use copper pipes thinner than 0.8mm even when it is available on the market.

NOTE

Refer to the "6-6. Instructions for Re-use Piping of R22 or R407C".

Table 6-2-1 Thicknesses of annealed copper pipes

		Thickness (mm)	
Nominal diameter	Outer diameter (mm)	R410A or R32	R22
1/4	6.4	0.80	0.80
3/8	9.5	0.80	0.80
1/2	12.7	0.80	0.80
5/8	15.9	1.00	1.00

1. Joints

For copper pipes, flare joints or socket joints are used. Prior to use, be sure to remove all contaminants.

a) Flare Joints

Flare joints used to connect the copper pipes cannot be used for piping whose outer diameter exceeds 20 mm. In such a case, socket joints can be used.

Sizes of flare pipe ends, flare joint ends and flare nuts are as shown in Tables 6-2-3 to 6-2-5 below.

b) Socket Joints

Socket joints are such that they are braced for connections, and used mainly for thick piping whose diameter is larger than 20 mm. Thicknesses of socket joints are as shown in Table 6-2-2.

Table 6-2-2 Minimum thicknesses of socket joints

Nominal diameter	Reference outer diameter of copper pipe jointed (mm)	Minimum joint thickness (mm)
1/4	6.4	0.50
3/8	9.5	0.60
1/2	12.7	0.70
5/8	15.9	0.80

6-2-2. Processing of Piping Materials

When performing the refrigerant piping installation, care should be taken to ensure that water or dust does not enter the pipe interior, that no other oil other than lubricating oils used in the installed air conditioner is used, and that refrigerant does not leak.

When using lubricating oils in the piping processing, use such lubricating oils whose water content has been removed. When stored, be sure to seal the container with an airtight cap or any other cover.

1. Flare Processing Procedures and Precautions

a) Cutting the Pipe

By means of a pipe cutter, slowly cut the pipe so that it is not deformed.

b) Removing Burrs and Chips

If the flared section has chips or burrs, refrigerant leakage may occur.

Carefully remove all burrs and clean the cut surface before installation.

c) Insertion of Flare Nut

d) Flare Processing

Make certain that a clamp bar and copper pipe have been cleaned.

By means of the clamp bar, perform the flare processing correctly.

Use either a flare tool for R410A / R32 or conventional flare tool.

Flare processing dimensions differ according to the type of flare tool.

When using a conventional flare tool, be sure to secure "dimension A" by using a gauge for size adjustment.

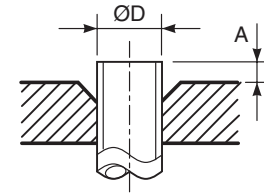

Fig. 6-2-1 Flare processing dimensions

Table 6-2-3 Dimensions related to flare processing for R410A or R32 / R22

Nominal diameter	Outer diameter (mm)	Thickness (mm)	A (mm)				
			Flare tool for R410A, R22 clutch type	Conventional flare tool (R410A or R32)		Conventional flare tool (R22)	
				Clutch type	Wing nut type	Clutch type	Wing nut type
1/4	6.4	0.8	0 to 0.5	1.0 to 1.5	1.5 to 2.0	0.5 to 1.0	1.0 to 1.5
3/8	9.5	0.8	0 to 0.5	1.0 to 1.5	1.5 to 2.0	0.5 to 1.0	1.0 to 1.5
1/2	12.7	0.8	0 to 0.5	1.0 to 1.5	2.0 to 2.5	0.5 to 1.0	1.5 to 2.0
5/8	15.9	1.0	0 to 0.5	1.0 to 1.5	2.0 to 2.5	0.5 to 1.0	1.5 to 2.0
3/4	19.1	1.2	0 to 0.5	1.0 to 1.5	2.0 to 2.5	—	—

Table 6-2-4 Flare and flare nut dimensions for R410A or R32

Nominal diameter	Outer diameter (mm)	Thickness (mm)	Dimension (mm)				Flare nut width (mm)
			A	B	C	D	
1/4	6.4	0.8	9.1	9.2	6.5	13	17
3/8	9.5	0.8	13.2	13.5	9.7	20	22
1/2	12.7	0.8	16.6	16.0	12.9	23	26
5/8	15.9	1.0	19.7	19.0	16.0	25	29
3/4	19.1	1.2	24.0	—	19.2	28	36

Table 6-2-5 Flare and flare nut dimensions for R22

Nominal diameter	Outer diameter (mm)	Thickness (mm)	Dimension (mm)				Flare nut width (mm)
			A	B	C	D	
1/4	6.4	0.8	9.1	9.2	6.5	13	17
3/8	9.5	0.8	13.0	13.5	9.7	20	22
1/2	12.7	0.8	16.2	16.0	12.9	20	24
5/8	15.9	1.0	19.4	19.0	16.0	23	27
3/4	19.1	1.0	23.3	24.0	19.2	34	36

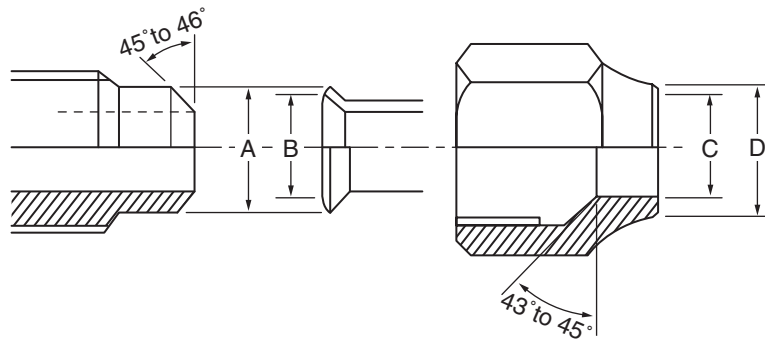

Fig. 6-2-2 Relations between flare nut and flare seal surface

2. Flare Connecting Procedures and Precautions

- a) Make sure that the flare and union portions do not have any scar or dust, etc.
- b) Correctly align the processed flare surface with the union axis.
- c) Tighten the flare with designated torque by means of a torque wrench.
 The tightening torque for R410A or R32 is the same as that for conventional R22.
 Incidentally, when the torque is weak, the gas leakage may occur.
 When it is strong, the flare nut may crack and may be made non-removable.
 When choosing the tightening torque, comply with values designated by manufacturers.
 Table 6-2-6 shows reference values.

NOTE

When applying oil to the flare surface, be sure to use oil designated by the manufacturer.
 If any other oil is used, the lubricating oils may deteriorate and cause the compressor to burn out.

Table 6-2-6 Tightening torque of flare for R410A or R32 [Reference values]

Nominal diameter	Outer diameter (mm)	Tightening torque N•m (kgf•m)	Tightening torque of torque wrenches available on the market N•m (kgf•m)
1/4	6.4	14 to 18 (1.4 to 1.8)	16 (1.6), 18 (1.8)
3/8	9.5	33 to 42 (3.3 to 4.2)	42 (4.2)
1/2	12.7	50 to 62 (5.0 to 6.2)	55 (5.5)
5/8	15.9	68 to 82 (6.8 to 8.2)	65 (6.5)
3/4	19.1	100 to 120 (10.0 to 12.0)	—

6-3. Tools

6-3-1. Required Tools

Refer to the “4. Tools” (Page 16)

6-4. Recharging of Refrigerant

When it is necessary to recharge refrigerant, charge the specified amount of new refrigerant according to the following steps.

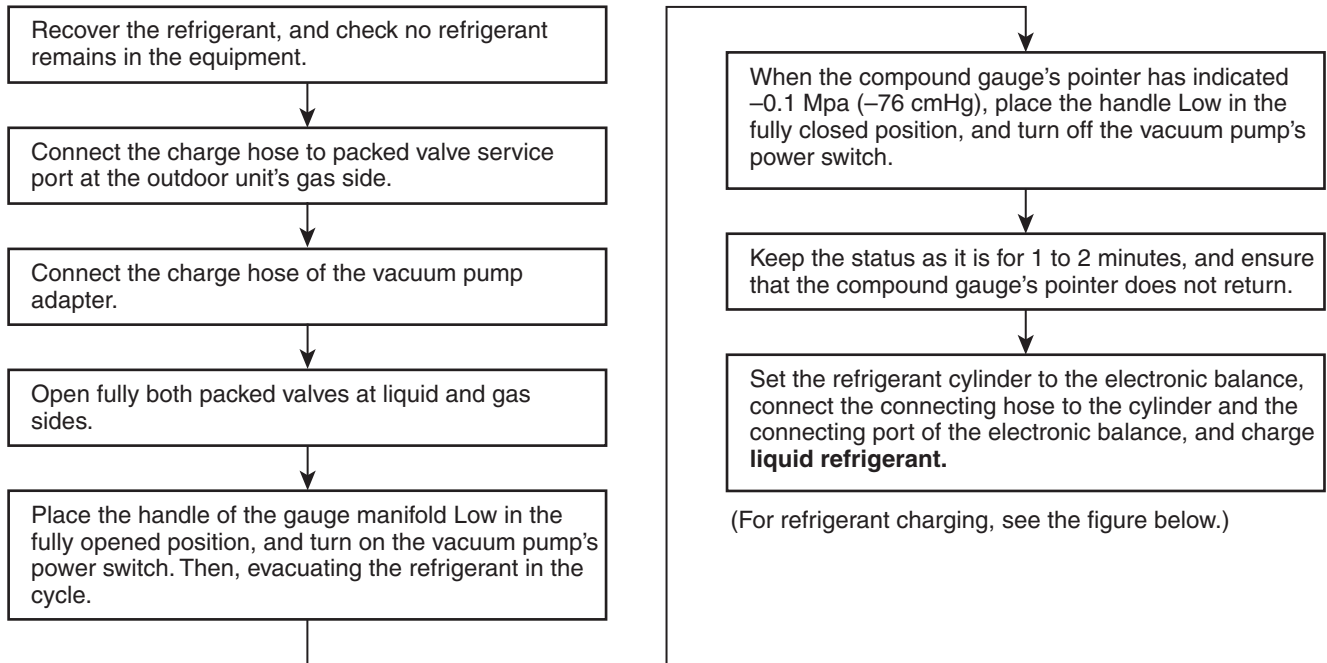

- 1) Never charge refrigerant exceeding the specified amount.
- 2) If the specified amount of refrigerant cannot be charged, charge refrigerant **bit by bit** in COOL mode.
- 3) Do not carry out additional charging.

When additional charging is carried out if refrigerant leaks, the refrigerant composition changes in the refrigeration cycle, which changes characteristics of the air conditioner, refrigerant exceeding the specified amount is charged, and working pressure in the refrigeration cycle becomes abnormally high pressure, and may cause a rupture or personal injury.

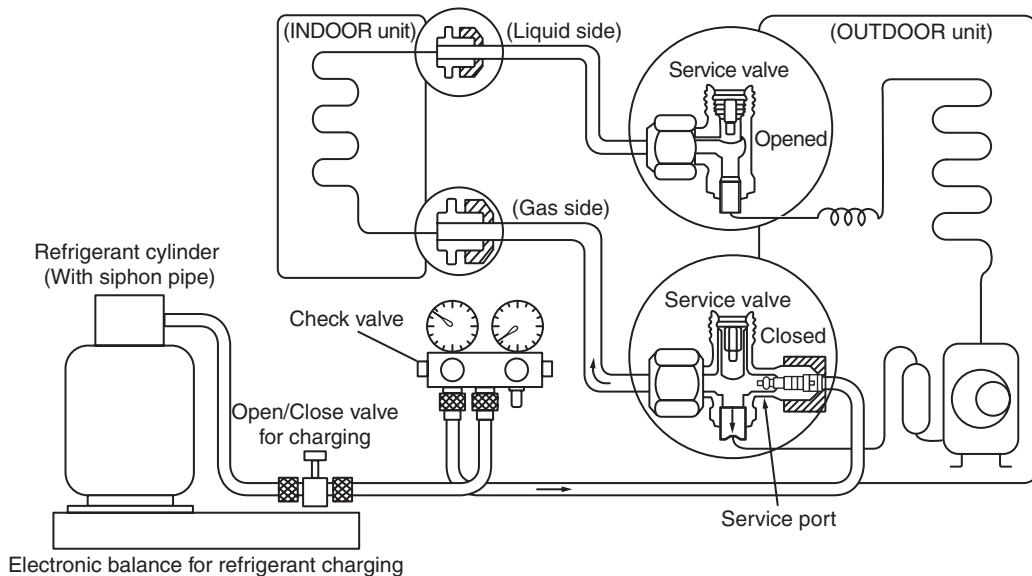

Fig. 6-4-1 Configuration of refrigerant charging

-
- 1) Be sure to make setting so that **liquid** can be charged.
 - 2) When using a cylinder equipped with a siphon, liquid can be charged without turning it upside down.
-

R32 refrigerant is a Single-component refrigerant that does not change its composition. Although it is possible to charge the refrigerant with either liquid or gas, charge it with liquid. (If using gas for charging, composition of the refrigerant changes and then characteristics of the air conditioner change.)

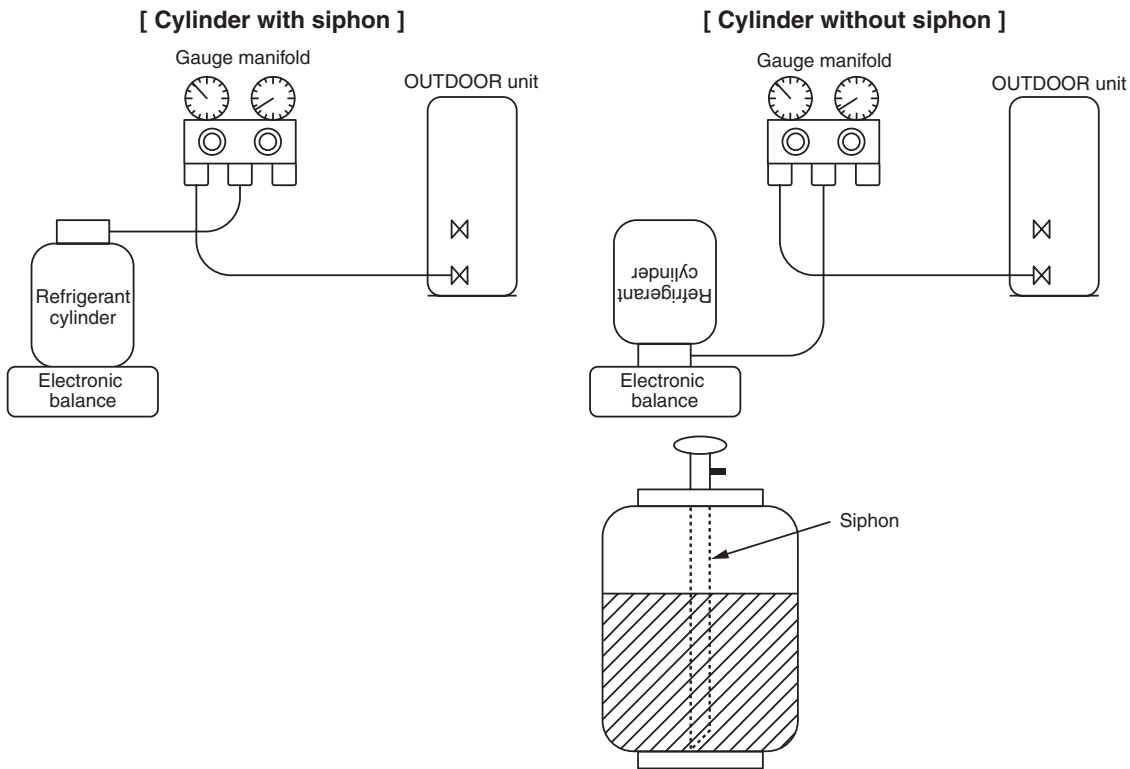

Fig. 6-4-2

6-5. Brazing of Pipes

6-5-1. Materials for Brazing

1. Silver brazing filler

Silver brazing filler is an alloy mainly composed of silver and copper.

It is used to join iron, copper or copper alloy, and is relatively expensive though it excels in solder ability.

2. Phosphor bronze brazing filler

Phosphor bronze brazing filler is generally used to join copper or copper alloy.

3. Low temperature brazing filler

Low temperature brazing filler is generally called solder, and is an alloy of tin and lead. Since it is weak in adhesive strength, do not use it for refrigerant pipes.

-
- 1) Phosphor bronze brazing filler tends to react with sulfur and produce a fragile compound water solution, which may cause a gas leakage. Therefore, use any other type of brazing filler at a hot spring resort, etc., and coat the surface with a paint.
 - 2) When performing brazing again at time of servicing, use the same type of brazing filler.
-

6-5-2. Flux

1. Reason why flux is necessary

- By removing the oxide film and any foreign matter on the metal surface, it assists the flow of brazing filler.
- In the brazing process, it prevents the metal surface from being oxidized.
- By reducing the brazing filler's surface tension, the brazing filler adheres better to the treated metal.

2. Characteristics required for flux

- Activated temperature of flux coincides with the brazing temperature.
- Due to a wide effective temperature range, flux is hard to carbonize.
- It is easy to remove slag after brazing.
- The corrosive action to the treated metal and brazing filler is minimum.
- It excels in coating performance and is harmless to the human body.

As the flux works in a complicated manner as described above, it is necessary to select an adequate type of flux according to the type and shape of treated metal, type of brazing filler and brazing method, etc.

3. Types of flux

• Noncorrosive flux

Generally, it is a compound of borax and boric acid.

It is effective in case where the brazing temperature is higher than 800°C.

• Activated flux

Most of fluxes generally used for silver brazing are this type.

It features an increased oxide film removing capability due to the addition of compounds such as potassium fluoride, potassium chloride and sodium fluoride to the borax-boric acid compound.

4. Piping materials for brazing and used brazing filler/flux

Piping material	Used brazing filler	Used flux
Copper - Copper	Phosphor copper	Do not use
Copper - Iron	Silver	Paste flux
Iron - Iron	Silver	Vapor flux

- 1) Do not enter flux into the refrigeration cycle.
- 2) When chlorine contained in the flux remains within the pipe, the lubricating oil deteriorates. Therefore, use a flux which does not contain chlorine.
- 3) When adding water to the flux, use water which does not contain chlorine (e.g. distilled water or ion-exchange water).
- 4) Remove the flux after brazing.

6-5-3. Brazing

As brazing work requires sophisticated techniques, experiences based upon a theoretical knowledge, it must be performed by a person qualified. In order to prevent the oxide film from occurring in the pipe interior during brazing, it is effective to proceed with brazing while letting dry Nitrogen gas flow.

Never use gas other than Nitrogen gas.

1. Brazing method to prevent oxidation

- 1) Attach a reducing valve and a flow-meter to the Nitrogen gas cylinder.
- 2) Use a copper pipe to direct the piping material, and attach a flow-meter to the cylinder.
- 3) Apply a seal onto the clearance between the piping material and inserted copper pipe for Nitrogen in order to prevent backflow of the Nitrogen gas.
- 4) When the Nitrogen gas is flowing, be sure to keep the piping end open.
- 5) Adjust the flow rate of Nitrogen gas so that it is lower than 0.05 m³/Hr or 0.02 MPa (0.2kgf/cm²) by means of the reducing valve.
- 6) After performing the steps above, keep the Nitrogen gas flowing until the pipe cools down to a certain extent (temperature at which pipes are touchable with hands).
- 7) Remove the flux completely after brazing.

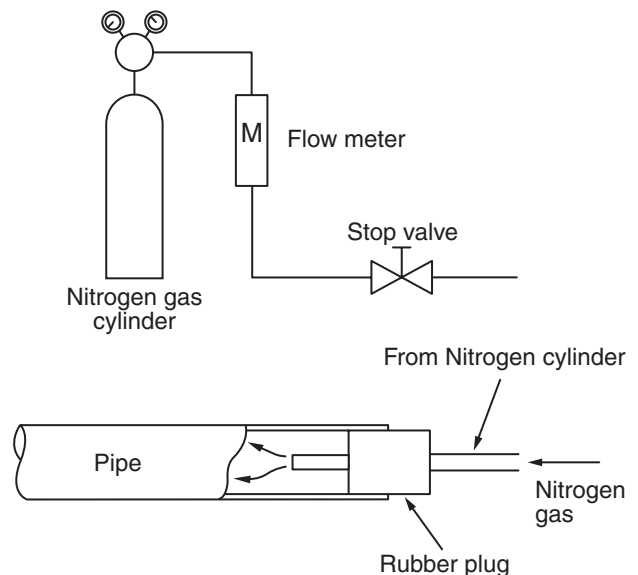

Fig. 6-5-1 Prevention of oxidation during brazing

6-6. Instructions for Re-use Piping of R22 or R407C

Instruction of Works:

The existing R22 and R407C piping can be reused for our digital inverter R32 products installations.

WARNING

Confirming the existence of scratches or dents on the existing pipes and confirming the reliability of the pipe strength are conventionally referred to the local site. If the specified conditions can be cleared, it is possible to update existing R22 and R407C pipes to those for R32 models.

6-6-1. Basic Conditions Needed to Reuse the Existing Pipe

Check and observe three conditions of the refrigerant piping works.

1. Dry (There is no moisture inside of the pipes.)
2. Clean (There is no dust inside of the pipes.)
3. Tight (There is no refrigerant leak.)

6-6-2. Restricted Items to Use the Existing Pipes

In the following cases, the existing pipes cannot be reused as they are. Clean the existing pipes or exchange them with new pipes.

1. When a scratch or dent is heavy, be sure to use the new pipes for the works.
2. When the thickness of the existing pipe is thinner than the specified "Pipe diameter and thickness" be sure to use the new pipes for the works.
 - The operating pressure of R32 is high. If there is a scratch or dent on the pipe or a thinner pipe is used, the pressure strength may be inadequate, which may cause the pipe to break in the worst case.

* Pipe diameter and thickness (mm)

Reference outside diameter (mm)	Wall thickness (mm)	Material
6.4	0.8	—
9.5	0.8	—
12.7	0.8	—
15.9	1.0	—

- In case that the pipe diameter is $\varnothing 12.7$ mm or less and the thickness is less than 0.7 mm, be sure to use the new pipes for works.
3. The pipes are left as coming out or gas leaks. (Poor refrigerant)
 - There is possibility that rain water or air including moisture enters in the pipe.
 4. Refrigerant recovery is impossible. (Refrigerant recovery by the pump-down operation on the existing air conditioner)
 - There is possibility that a large quantity of poor oil or moisture remains inside of the pipe.

5. A dryer on the market is attached to the existing pipes.
 - There is possibility that copper green rust generated.
6. Check the oil when the existing air conditioner was removed after refrigerant had been recovered. In this case, if the oil is judged as clearly different compared with normal oil
 - The refrigerator oil is copper rust green : There is possibility that moisture is mixed with the oil and rust forms inside of the pipe.
 - There is discolored oil, a large quantity of the remains, or bad smell.
 - A large quantity of sparkle remained wear-out powder is observed in the refrigerator oil.
7. The air conditioner which compressor was exchanged due to a trouble compressor. When the discolored oil, a large quantity of the remains, mixture of foreign matter, or a large quantity of sparkle remained wear-out powder is observed, the cause of trouble will occur.
8. Installation and removal of the air conditioner are repeated with temporary installation by lease and etc.
9. In case that type of the refrigerator oil of the existing air conditioner is other than the following oil (Mineral oil), Suniso, Freol-S, MS (Synthetic oil), alkyl benzene (HAB, Barrel-freeze), ester series, PVE only of ether series.
 - Winding-insulation of the compressor may become inferior.

NOTE

The above descriptions are results of confirmation by our company and they are views on our air conditioners, but they do not guarantee the use of the existing pipes of the air conditioner that adopted R410A in other companies.

6-6-3. Branching Pipe for Simultaneous Operation System

- In the concurrent twin system, when TOSHIBA-specified branching pipe is used, it can be reused. Branching pipe model name: RBC-TWP30E, RBC-TWP50E, RBC-TRP100E On the existing air conditioner for simultaneous operation system (twin system), there is a case of using branch pipe that has insufficient compressive strength. In this case please change it to the branch pipe for R32 or R410A.

6-6-4. Curing of Pipes

When removing and opening the indoor unit or outdoor unit for a long time, cure the pipes as follows:

- Otherwise rust may forms when moisture or foreign matter due to dewing enters in the pipes.
- The rust cannot be removed by cleaning, and a new piping work is necessary.

Place position	Term	Curing manner
Outdoors	1 month or more	Pinching
	Less than 1 month	Pinching or taping
Indoors	Every time	

6-6-5. Final Installation Checks

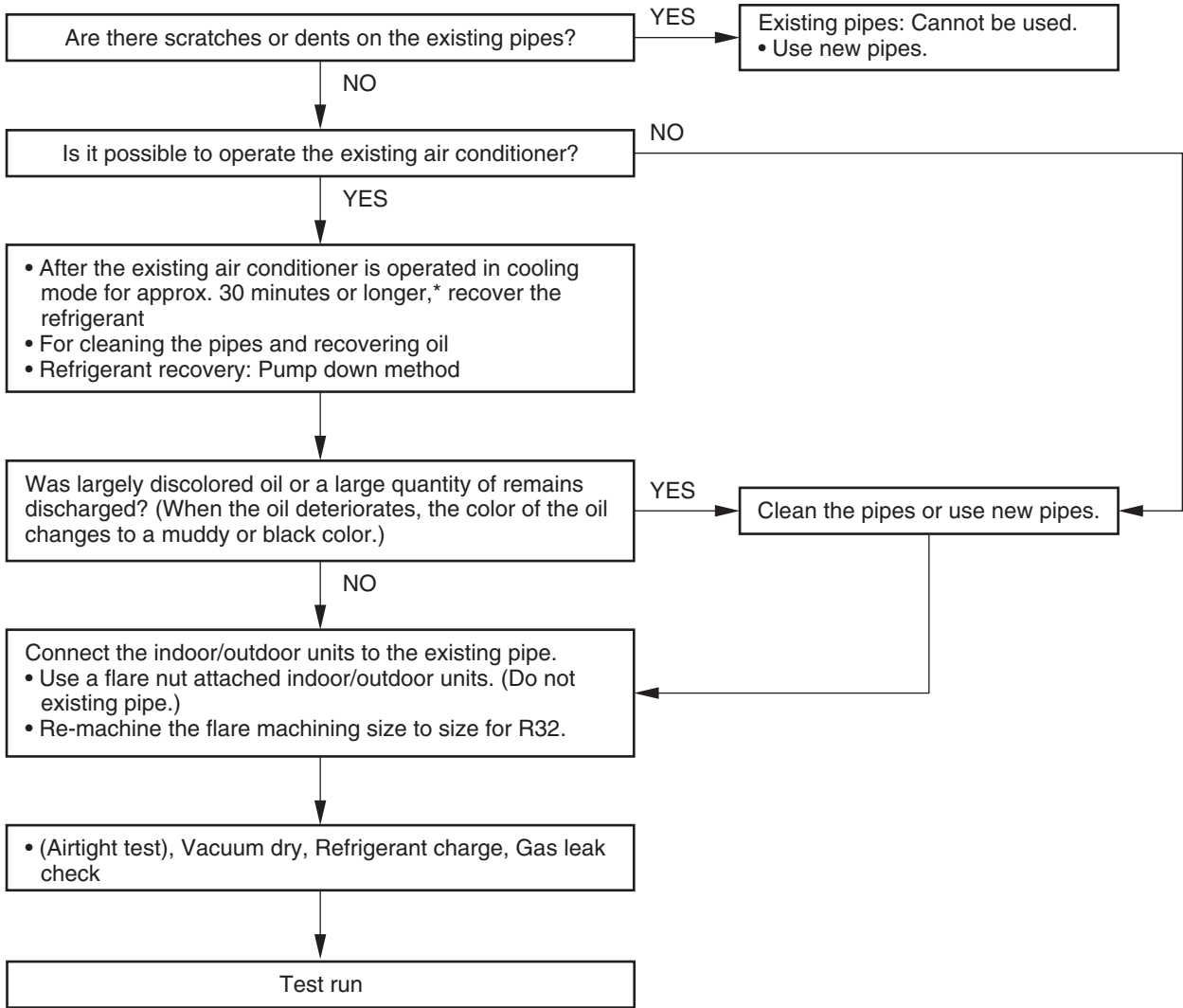

6-6-6. Handling of Existing Pipe

When using the existing pipe, carefully check it for the following:

- Wall thickness (within the specified range)
- Scratches and dents
- Water, oil, dirt, or dust in the pipe
- Flare looseness and leakage from welds
- Deterioration of copper pipe and heat insulator
- Before recovering the refrigerant in the existing system, perform a cooling operation for at least 30 minutes.

Cautions for using existing pipe

- Do not reuse a flare nut to prevent gas leaks. Replace it with the supplied flare nut and then process it to a flare.
- Blow nitrogen gas or use an appropriate means to keep the inside of the pipe clean. If discolored oil or much residue is discharged, wash the pipe.
- Check welds, if any, on the pipe for gas leaks.
- There may be a problem with the pressure resistance of the branch pipes of the existing piping. Replace them with branch pipes (sold separately).

When the pipe corresponds to any of the following, do not use it. Install a new pipe instead.

- The pipe has been opened (disconnected from indoor unit or outdoor unit) for a long period.
- The pipe has been connected to an outdoor unit that does not use refrigerant R22, R410A, R32 R407C.
- The existing pipe must have a wall thickness equal to or larger than the following thicknesses.

Reference outside diameter (mm)	Wall thickness (mm)	Material
6.4	0.8	—
9.5	0.8	—
12.7	0.8	—
15.9	1.0	—
19.1	1.2	—
22.2	1.0	Half hard
28.6	1.0	Half hard

- Do not use any pipe with a wall thickness less than these thicknesses due to insufficient pressure capacity.

6-6-7. Recovering Refrigerant

Use the refrigerant recovery equipment to recover the refrigerant.

6-7. Charging additional refrigerant

Amount of additional refrigerant shall be restricted by the following explanation to ensure the reliability. Miss-charging leads to the abnormal high pressure in the refrigerant cycle, causing a rupture, an injury and a compressor malfunction.

6-7-1. [Assumed gas leak]

The refrigerant can be charged only when the amount of a leak such as a slow-leak found at the installation work can be ensured that it is within the additional limits shown in the following. Recharge the refrigerant if the amount of leakage is unknown when you feel “Cooling is not working well” or “Heating is not working well”.

6-7-2. [Limiting the additional charge]

- The maximum amount of additional refrigerant shall be up to 10 % of the normal amount of the refrigerant. If no improvement in symptoms can be found at the above limitation, recover all gases and recharge the normal amount of refrigerant.
- If the slow leak is found at the installation work and the connection pipe length is 15 m or less, tighten the flare nut at the leak point and do not add the refrigerant.

6-7-3. [Cautions on charging additional refrigerant]

- When charging additional refrigerant, use a balance with an accuracy of more than 10g scale. Do not use a health-meter etc.
- If the refrigerant gas leaks, find the leakage point and repair it securely. Though the refrigerant gas itself is innocuous, if it touch a fire source such as fan heater, stove or kitchen stove, noxious gas may occur.
- When charging the refrigerant, charge with liquid refrigerant. Work carefully and charge it little by little since it may be rapidly charged due to the liquid state.

6-8. General safety precautions for using R32 refrigerant

6-8-1. Recovery

- When removing refrigerant from a system, either for servicing or decommissioning, it is recommended good practice that all refrigerants are removed safely.
- When transferring refrigerant into cylinders, ensure that only appropriate refrigerant recovery cylinders are employed.
- Ensure that the correct number of cylinders for holding the total system charge are available.
- All cylinders to be used are designated for the recovered refrigerant and labelled for that refrigerant (i.e. special cylinders for the recovery of refrigerant).
- Cylinders shall be complete with pressure relief valve and associated shut-off valves in good working order.
- Empty recovery cylinders are evacuated and, if possible, cooled before recovery occurs.
- The recovery equipment shall be in good working order with a set of instructions concerning the equipment that is at hand and shall be suitable for the recovery of flammable refrigerants.
- In addition, a set of calibrated weighing scales shall be available and in good working order.
- Hoses shall be complete with leak-free disconnect couplings and in good condition.
- Before using recovery machine check that it is satisfactory working order, has been properly maintained and that any associated electrical components are sealed to prevent ignition in the event of a refrigerant release.
- Consult manufacturer if in doubt.
- The recovered refrigerant shall be returned to the refrigerant supplier in the correct recovery cylinder, and the relevant Waste Transfer Note arranged.
- Do not mix refrigerants in recovery units and especially not in cylinders.
- If compressors or compressor oils are to be removed, ensure that they have been evacuated to an acceptable level to make certain that flammable refrigerant does not remain within the lubricant.
- The evacuation process shall be carried out prior to returning the compressor to the suppliers.
- Only electric heating to the compressor body shall be employed to accelerate this process.
- When oil is drained from a system, it shall be carried out safely.

6-8-2. Decommissioning

- Before carrying out this procedure, it is essential that the technician is completely familiar with the equipment and all its details. Only a qualified installer (*1) or qualified service person (*1) is allowed to do this work.
- It is recommended good practice that all refrigerants are recovered safely.
- Prior to the task being carried out, an oil and refrigerant sample shall be taken in case analysis is required prior to re-use of reclaimed refrigerant.
- It is essential that electrical power is available before the task is commenced.

-
- a) Become familiar with the equipment and its operation.
 - b) Isolate system electrically.
 - c) Before attempting the procedure ensure that :
 - Mechanical handling equipment is available, if required, for handling refrigerant cylinders;
 - All personal protective equipment is available and being used correctly;
 - The recovery process is supervised at all times by a competent person;
 - Recovery equipment and cylinders conform to the appropriate standards.
 - d) Pump down refrigerant system, if possible.
 - e) If a vacuum is not possible, make a manifold so that refrigerant can be removed from the various parts of the system.
 - f) Make sure that cylinder is situated on the scales before recovery takes place.
 - g) Start the recovery machine and operate in accordance with manufacturer's instructions.
 - h) Do not overfill cylinders (No more than 80% volume liquid change).
 - i) Do not exceed the maximum working pressure of the cylinder, even temporarily.
 - j) When the cylinders have been filled correctly and the process complete, make sure that the cylinders and the equipment are removed from site promptly and all isolation valves on the equipment are closed off.
 - k) Recovered refrigerant shall not be changed into another refrigerant system unless it has been cleaned and checked.
-

6-8-3. Labelling

- Equipment shall be labelled stating that it has been de-commissioned and emptied of refrigerant.
- The label shall be dated and signed.
- Ensure that are labels on the equipment stating the equipment contains flammable refrigerant.

7. CIRCUIT CONFIGURATION AND CONTROL SPECIFICATIONS

7-1. Outdoor Unit Control

7-1-1. Print Circuit Board, MCC-1596 (Compressor IPDU)

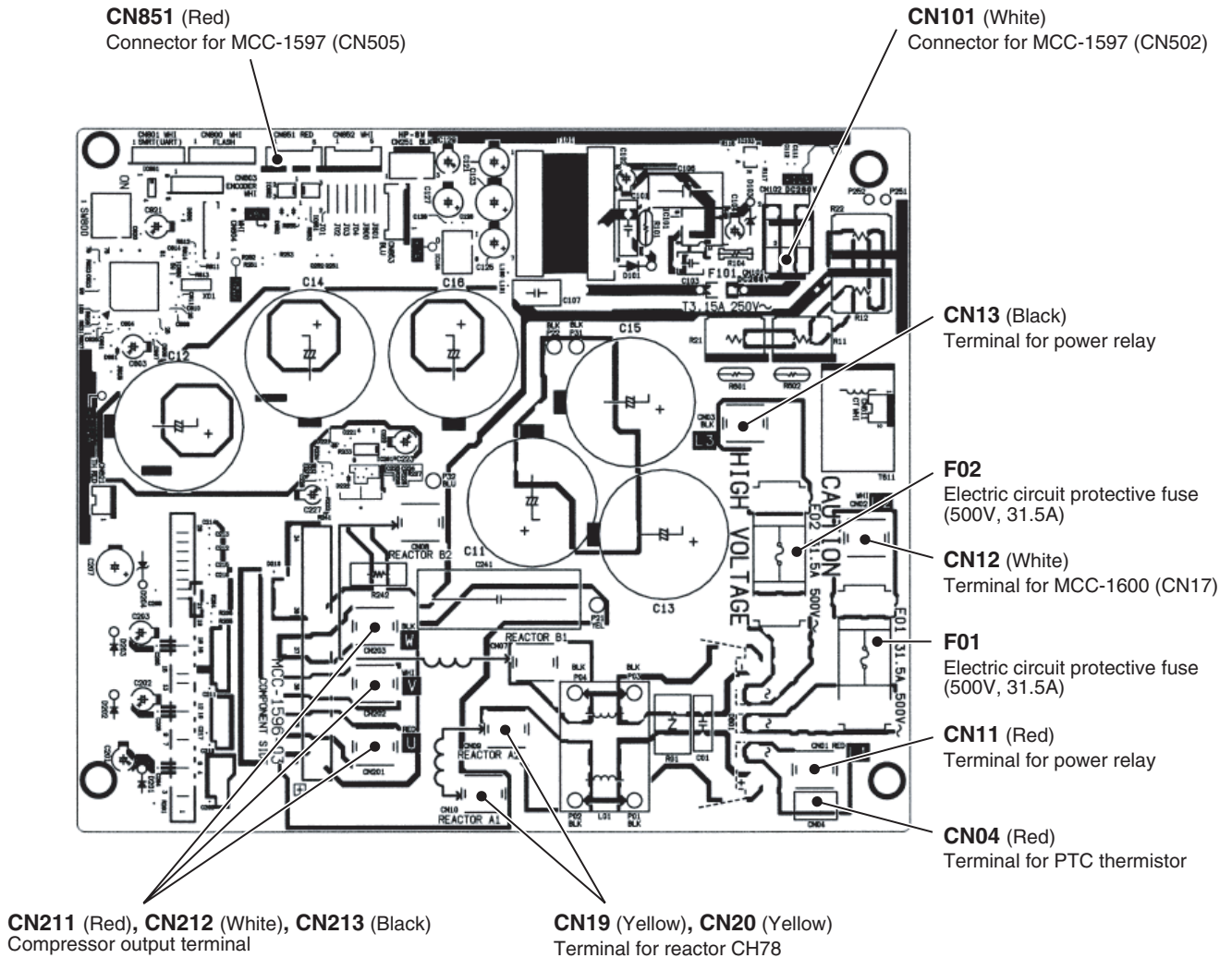

7-1-2. Print Circuit Board, MCC-1597 (Fan Motor IPDU)

CN750 (White)
Fan motor output (Upper side)

CN700 (Blue)
Fan motor output (Lower side)

CN500 (Red)
Connector for MCC-1600 (CN23)
and reactor CH68

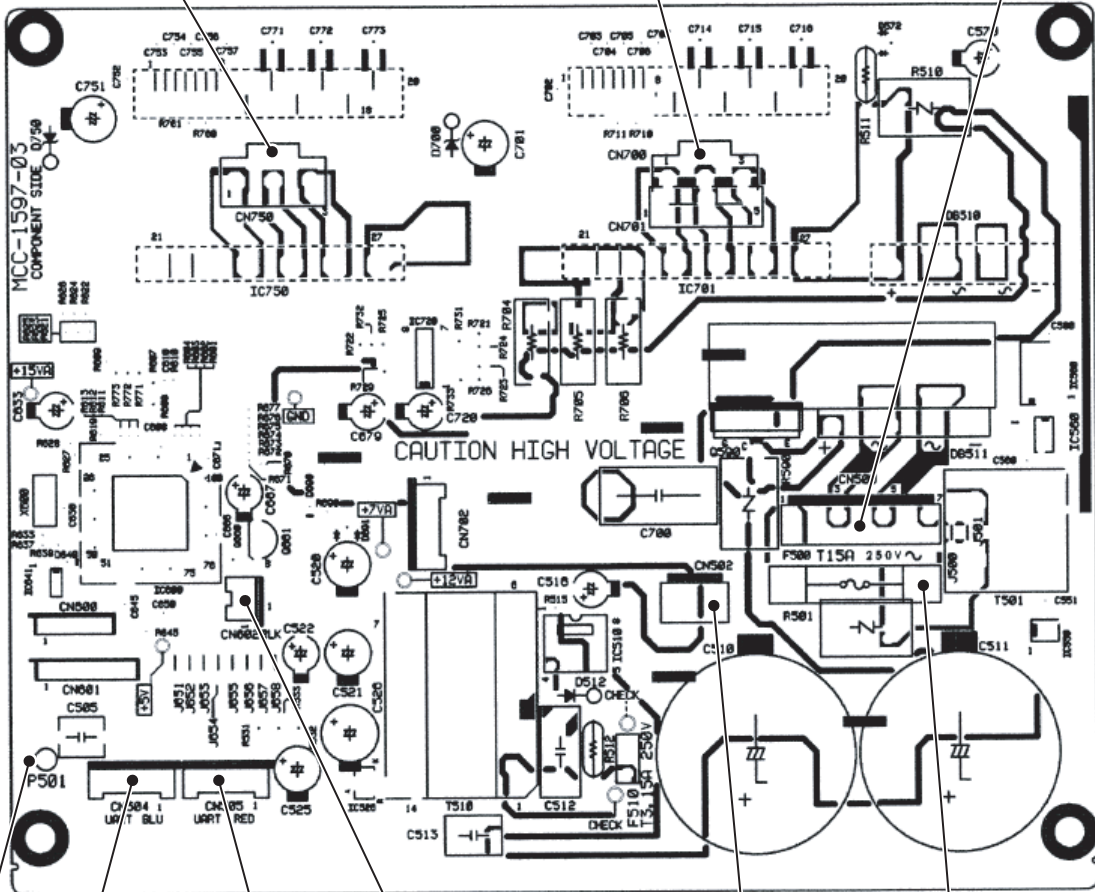

CN504 (Blue)
Connector for MCC-1599
(CN802)

CN602 (Black)
Connector for MCC-1600 (CN51)

F500
Electric circuit protective fuse
(250V, 15A)

P501 (Black)
Lead wire for grounding

CN505 (Red)
Connector for MCC-1596 (CN851)

CN502 (White)
Connector for MCC-1596 (CN101)

7-1-3. Print Circuit Board, MCC-1599 (Interface (CDB))

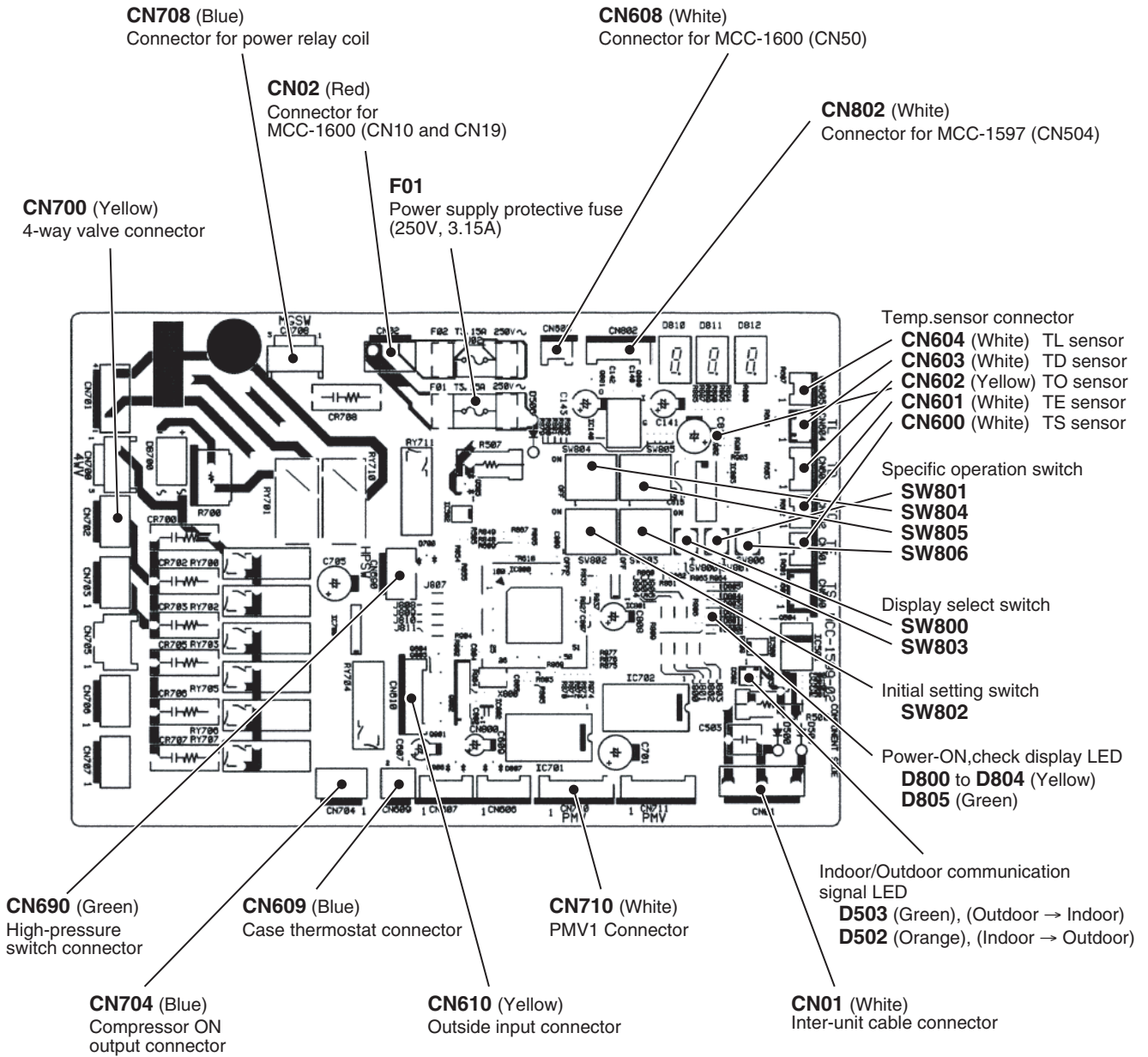

7-1-4. Print Circuit Board, MCC-1600 (Noise Filter)

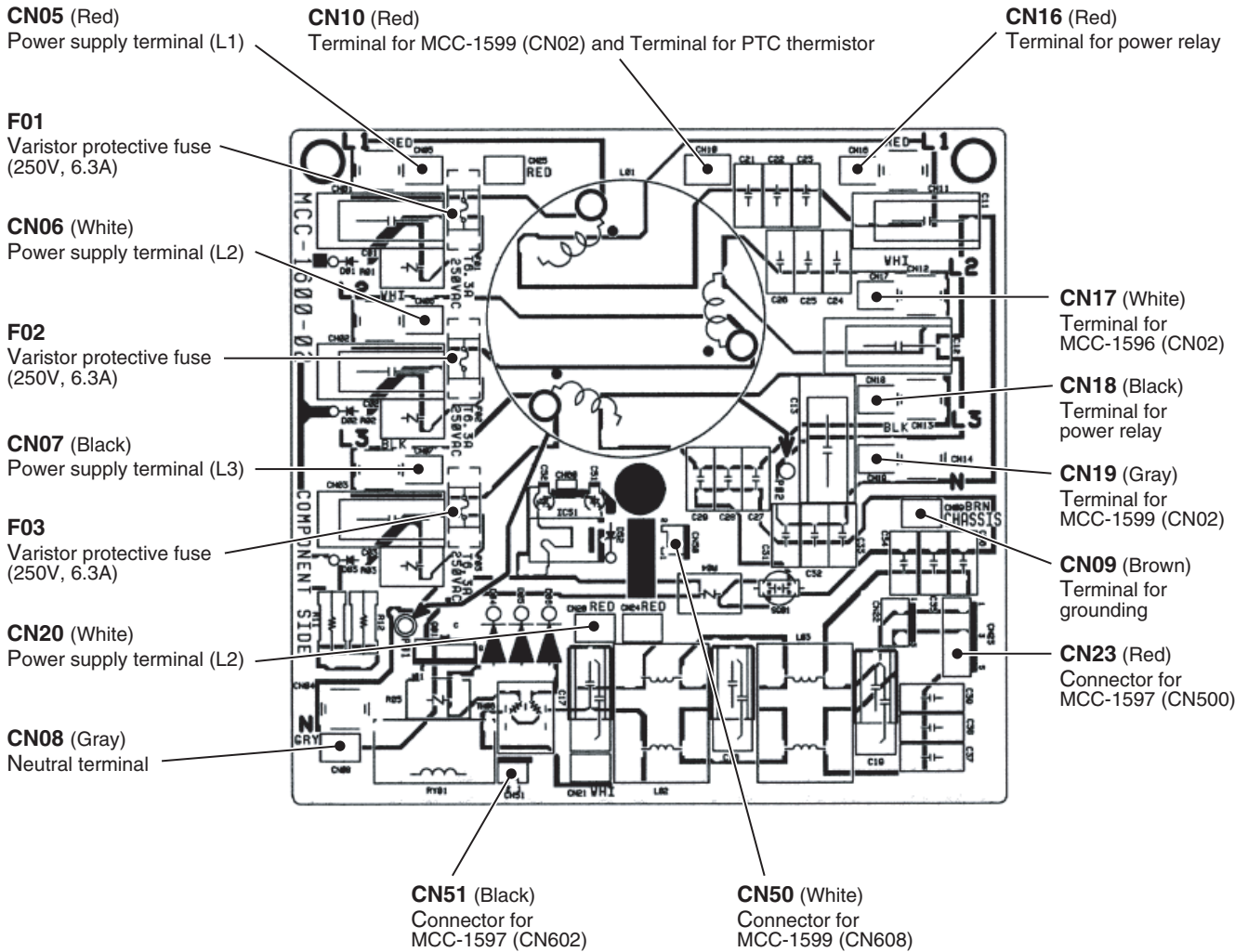

7-2. Outline of Main Controls

1. PMV (Pulse Motor Valve) control

- 1) PMV is controlled between 30 and 500 pulses during operation.
- 2) In cooling operation, PMV is usually controlled with the temperature difference between TS sensor and TC sensor aiming 1 to 4K as the target value.
- 3) In heating operation, PMV is usually controlled with the temperature difference between TS sensor and TE sensor aiming -1 to 4K as the target value.
- 4) When the cycle excessively heated in both cooling and heating operation, PMV is controlled by TD sensor. The target value is usually 91°C in cooling operation and 96°C in heating operation.

REQUIREMENT

A sensor trouble may cause a liquid back-flow or abnormal overheat resulting in excessive shortening of the compressor life. In a case of trouble on the compressor, be sure to check there is no trouble in the resistance value or the refrigerating cycle of each sensor after repair and then start the operation.

2. Discharge temperature release control

- 1) When the discharge temperature did not fall or the discharge temperature rapidly went up by PMV control, this control lowers the operation frequency. It subdivides the frequency control up to 0.6Hz to stabilize the cycle.
- 2) When the discharge temperature detected an abnormal stop zone, the compressor stops and then restarts after 2 minutes 30 seconds.
The trouble counting is cleared when the operation continued for 10 minutes. If the trouble is detected by 4 times without clearing, the trouble is determined and restarting is not performed.
The cause is considered as excessively little amount of refrigerant, PMV trouble or clogging of the cycle.
- 3) For displayed contents of trouble, confirm on the check code list.

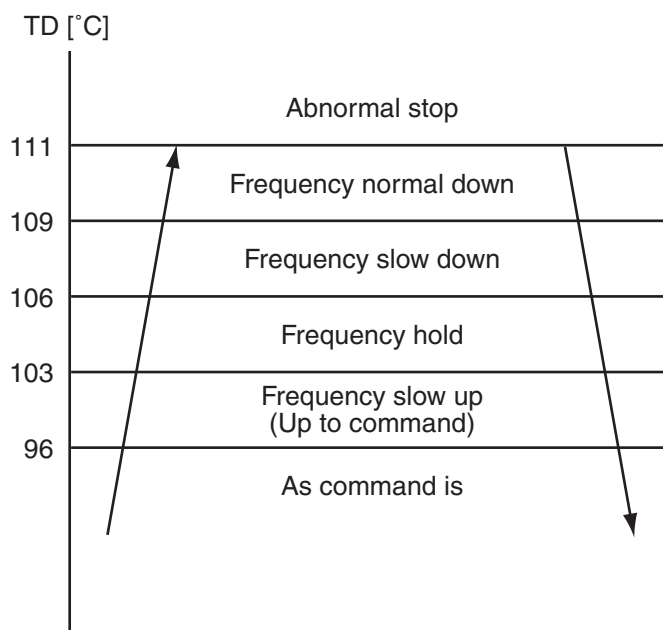

3. Outdoor fan control

Revolution frequency allocation of fan taps [rpm]

		W1	W2	W3	W4	W5	W6	W7	W8	W9	WA	WB	WC	WD	WE
GP110 to GP160	Up	200	240	240	260	320	380	480	500	530	610	640	660	720	780
	Down	—	—	200	280	360	400	500	520	550	630	660	700	740	820

3-1) Cooling fan control

- The outdoor fan is controlled by TL sensor, TO sensor and the operation frequency. The outdoor fan is controlled by every 1 tap of DC fan control (14 taps).
- Only for 60 seconds after the operation has started, the maximum fan tap corresponding to the zone in the following table is fixed and then the fan is controlled by temperature of TL sensor.

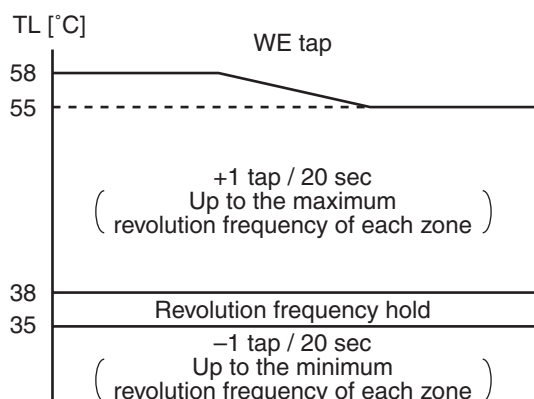

Temp. range	20 Hz or lower		20Hz to 45Hz		45Hz or higher	
	Min.	Max.	Min.	Max.	Min.	Max.
$38^{\circ}\text{C} \leq \text{TO}$	W6	WC	W8	WD	WA	WD
$29^{\circ}\text{C} \leq \text{TO} < 38^{\circ}\text{C}$	W5	WB	W7	WC*	W9	WC
$15^{\circ}\text{C} \leq \text{TO} < 29^{\circ}\text{C}$	W4	W8	W6	WA	W8	WC
$5^{\circ}\text{C} \leq \text{TO} < 15^{\circ}\text{C}$	W3	W6	W5	W8	W7	WA
$0^{\circ}\text{C} \leq \text{TO} < 5^{\circ}\text{C}$	W2	W4	W4	W6	W5	W8
$-4^{\circ}\text{C} \leq \text{TO} < 0^{\circ}\text{C}$	W2	W3	W3	W5	W4	W6
$\text{TO} < -4^{\circ}\text{C}$	W1	W2	W1	W4	W2	W6
TO trouble	W1	WC	W1	WD	W2	WD

* :WB for GP110

3-2) Heating fan control

- The outdoor fan is controlled by TE sensor, TO sensor and the operation frequency. (Control from minimum W1 to maximum (according to the following table))
- For 3 minutes after the operation has started, the maximum fan tap corresponding to the zone in the following table is fixed and then the fan is controlled by temperature of TE sensor.

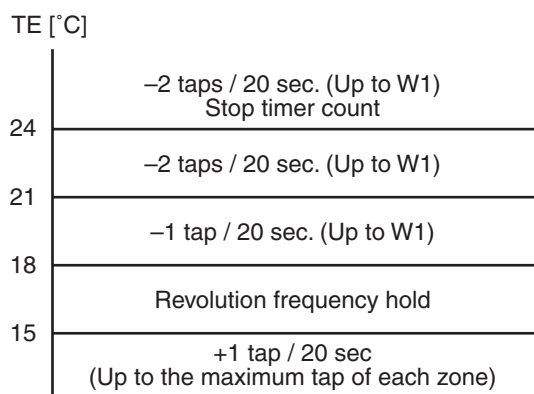

- When $\text{TE} \geq 24^{\circ}\text{C}$ continues for 5 minutes, the compressor stops. It is the same status as the normal thermostat-OFF without trouble display. The compressor restarts after approx. 2 minutes 30 seconds and this intermittent operation is not abnormal.
- In case that the status in item ③ generates frequently, stain on filter of the suction part of the indoor unit is considered. Clean the filter and then restart the operation.

Object: GP140 (GP160)

Temp. range	20 Hz or lower	20Hz to 45Hz	45Hz or higher
	Max.	Max.	Max.
$10^{\circ}\text{C} \leq \text{TO}$	W7	W8	W9
$5^{\circ}\text{C} \leq \text{TO} < 10^{\circ}\text{C}$	W9	WA	WB (WC)
$-3^{\circ}\text{C} \leq \text{TO} < 5^{\circ}\text{C}$	WB (WC)	WB (WC)	WC
$-10^{\circ}\text{C} \leq \text{TO} < -3^{\circ}\text{C}$	WC	WC	WC
$\text{TO} < -10^{\circ}\text{C}$	WD	WD	WD
TO trouble	WD	WD	WD

Object: GP110

Temp. range	20 Hz or lower	20Hz to 45Hz	45Hz or higher
	Max.	Max.	Max.
$10^{\circ}\text{C} \leq \text{TO}$	W7	W8	W9
$5^{\circ}\text{C} \leq \text{TO} < 10^{\circ}\text{C}$	W9	WA	WA
$-3^{\circ}\text{C} \leq \text{TO} < 5^{\circ}\text{C}$	WA	WA	WC
$-10^{\circ}\text{C} \leq \text{TO} < -3^{\circ}\text{C}$	WC	WC	WC
$\text{TO} < -10^{\circ}\text{C}$	WD	WD	WD
TO trouble	WD	WD	WD

4. Coil heating control

- 1) This control function heats the compressor by turning on the stopped compressor instead of a case heater.
It purposes to prevent stagnation of the refrigerant inside of the compressor.
- 2) As usual, turn on power of the compressor for the specified time before a test run after installation; otherwise a trouble of the compressor may be caused.
As same as a test run, it is recommended to turn on power of the compressor beforehand when starting operation after power of the compressor has been interrupted and left as it is for a long time.
- 3) A judgment for electricity is performed by TD and TO sensors.
If TO sensor is trouble, a backup control is automatically performed by TE sensor.
For a case of TO sensor trouble, judge it with outdoor LED display.
- 4) For every model, the power is turned off when TD is 30°C or more.

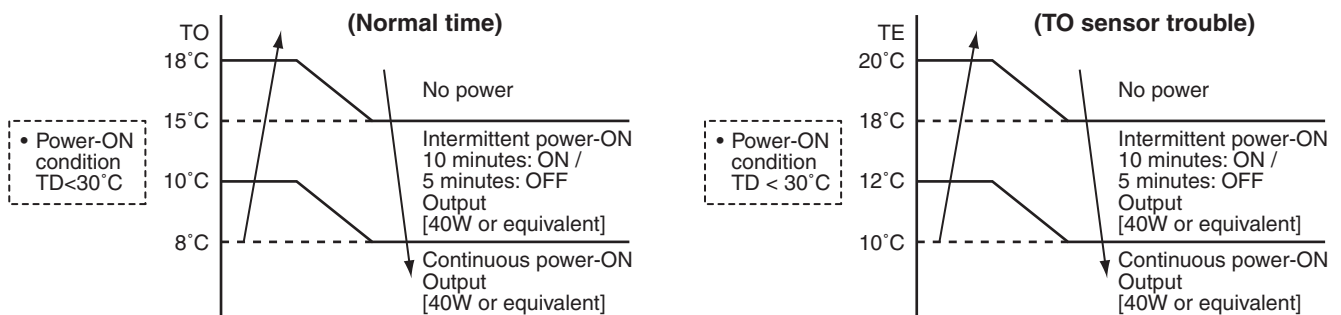

REQUIREMENT

While heating the winding wire by applying a current to it, an abnormal sound may be generated. It is not abnormal.

5. Short intermittent operation preventive control

- 1) For 3 to 10 minutes after operation start, in some cases, the compressor does not stop to protect the compressor even if receiving the thermostat-OFF signal from indoor.
However it is not abnormal status. (The operation continuance differs according to the operation status.)
- 2) When the operation stops by the remote controller, the operation does not continue.

6. Current release control

No. of revolutions of the compressor is controlled by AC current value detected by T611 on the outdoor P.C. board so that the input current of the inverter does not exceed the specified value.

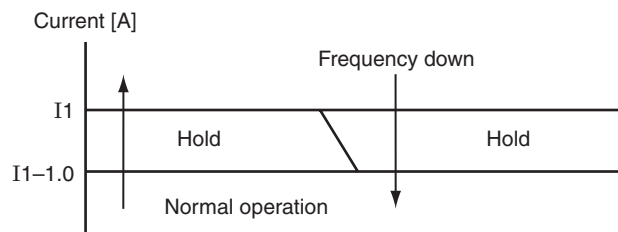

Objective mode I	GP110		GP140		GP160	
	COOL	HEAT	COOL	HEAT	COOL	HEAT
I1 value [A]	9.6	15.2	9.6	15.2	9.6	15.2

7. Current release value shift control

Current release control value (I1)

[A]

- 1) This control purposes to prevent troubles of the electronic parts such as the compressor driving elements and the compressor during cooling operation.
- 2) The current release control value (I1) is selected from the following table according to TO sensor value.

Temperature range	GP110	GP140	GP160
$47^{\circ}\text{C} \leq \text{TO}$	7.5	7.5	7.5
$39^{\circ}\text{C} \leq \text{To} < 47^{\circ}\text{C}$	7.5	8.7	9.6
$\text{TO} < 39^{\circ}\text{C}$	9.6	9.6	9.6
$\text{TO} < -5^{\circ}\text{C}$	7.5	8.7	9.6
TO trouble	7.5	7.5	7.5

8. Over-current protective control

- 1) When the over-current protective circuit detected an abnormal current, stop the compressor.
- 2) The compressor restarts after 2 minutes 30 seconds setting [1] as a trouble count.
- 3) When the trouble count [8] was found, determine a trouble and restart operation is not performed.
- 4) For the check code display contents, confirm on the check code list.

9. High-pressure release control

- 1) The operation frequency is controlled to restrain abnormal rising of high pressure by TL sensor in cooling operation and TC sensor in heating operation.
- 2) When TL sensor in cooling operation or TC sensor in heating operation detects abnormal temperature of the stop zone, stop the compressor and the trouble count becomes +1.
- 3) When the compressor stopped with 2), the operation restarts from the point of the normal operation zone (e point or lower) where it returned after 2 minutes 30 seconds.
- 4) The trouble count when the compressor stopped with 2) is cleared after the operation continued for 10 minutes.
If the trouble count becomes [10] without being cleared, the trouble is determined and reactivation is not performed.
- 5) For the check code display contents, confirm on the check code list.

HEAT TC / COOL TL
[°C]

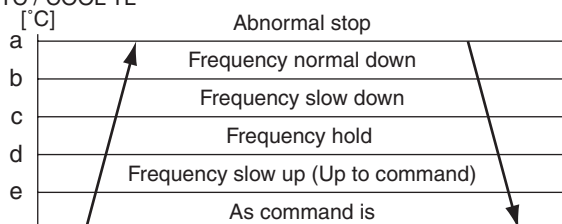

	HEAT	COOL
	TC	TL
a	62°C	63°C
b	57°C	62°C
c	55°C	60°C
d	53°C	58°C
e	49°C	54°C

10. Defrost control

- 1) In heating operation, defrost operation is performed when TE sensor satisfies any condition in A zone to D zone.
- 2) During defrosting operation, it finishes if TE sensor continued 12°C or higher for 3 seconds or continued $7^{\circ}\text{C} \leq \text{TE} < 12^{\circ}\text{C}$ for 1 minute.
The defrost operation also finishes when it continued for 10 minutes even if TE sensor temperature was 7°C or lower.
- 3) After defrost operation was reset, the compressor stopped for approx. 40 seconds and then the heating operation starts.

Start of heating operation

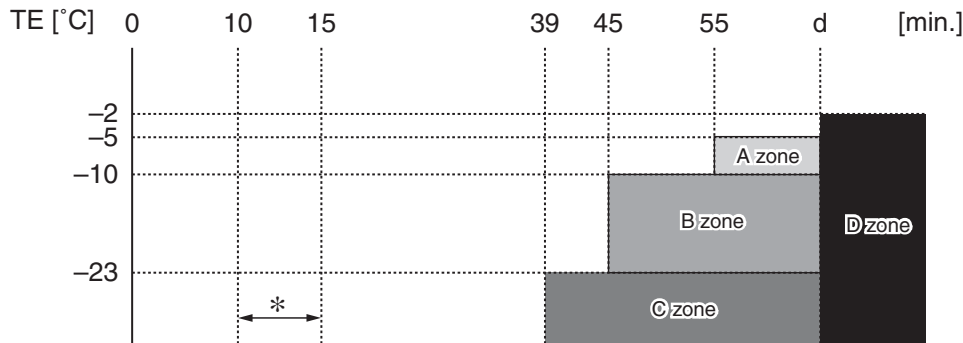

* The minimum TE value and To value between 10 and 15 minutes after heating operation has started are stored in memory as TEO and ToO, respectively.

	In normal To	In abnormal To
A zone	When status $(\text{TEO} - \text{TE}) - (\text{ToO} - \text{To}) \geq 3^{\circ}\text{C}$ continued for 20 seconds	When status $(\text{TEO} - \text{TE}) \geq 3^{\circ}\text{C}$ continued for 20 seconds
B zone	When status $(\text{TEO} - \text{TE}) - (\text{ToO} - \text{To}) \geq 2^{\circ}\text{C}$ continued for 20 seconds	When status $(\text{TEO} - \text{TE}) \geq 2^{\circ}\text{C}$ continued for 20 seconds
C zone	When status $(\text{TE} \leq -23^{\circ}\text{C})$ continued for 20 seconds	
D zone	When compressor operation status of $\text{TE} < -2^{\circ}\text{C}$ is calculated by d portion	

- 4) The time of above d can be changed by exchanging jumper [J805] with [J806] of the outdoor control P.C. board.
(Setting at shipment: 150 minutes)

J805	J806	d
○	○	150 minutes Setting at shipment
○	✕	90 minutes
✕	○	60 minutes
✕	✕	30 minutes

○ : Short circuit, ✕ : Open

11. High-pressure switch/Compressor case thermostat control

- 1) When the high-pressure switch or the compressor case thermostat operates, the operation of the compressor is terminated.
- 2) The compressor restarts after 5 minutes using [1] as a trouble count.
After restart, the trouble count is cleared when operation continues for 10 minutes or more.
- 3) A trouble is confirmed with the trouble count [10].
- 4) For the indicated contents of trouble, confirm on the check code list.

8. TROUBLESHOOTING

8-1. Summary of Troubleshooting

<Wired remote controller type>

1. Before troubleshooting

1) Required tools/instruments

- ⊕ and ⊖ screwdrivers, spanners, radio cutting pliers, nippers, push pins for reset switch
- Tester, thermometer, pressure gauge, etc.

2) Confirmation points before check

a) The following operations are normal.

1. Compressor does not operate.

- Does not 3-minute delay control work? (3 minutes after compressor stops)
- Is not the indoor unit under thermostat OFF control?
* Thermostat OFF : Indoor unit monitors whether the room temperature reaches setting temperature.
- Is not the remote controller under timer operation or fan mode?
- Is not an overflow trouble of drain water detected on the indoor unit?
- Does not outside high-temperature operation control work in heating operation?

2. Indoor fan does not rotate.

- Does not cool air discharge preventive control work in heating operation?

3. Outdoor fan does not rotate or air volume changes.

- Does not high-temperature release operation control work in heating operation?
- Does not outside low-temperature operation control work in cooling operation?
- Is not defrost operation performed?

4. ON/OFF operation cannot be performed from remote controller.

- Does not the central remote controller or the remote location ON/OFF control work?
- Is not automatic address being set up?
(When the power is turned on at the first time or when indoor unit address setting is changed, the operation cannot be performed for maximum approx. 5 minutes after power-ON.)
- Is not being carried out a test run by operation of the outdoor unit?

5. LED for the indoor unit and outdoor unit communication does not flash.

* LED is on the P.C. board of a outdoor unit.

- Does not standby power saving operation control work?
(LED does not flash, when the indoor unit and outdoor unit communication is being stopped during the standby power saving control. Operating service switches (SW01 or SW02) on the outdoor unit allow to restart the communication.)

b) Did you return the wiring to the initial positions?

c) Are connecting wiring of indoor unit and remote controller correct?

2. Troubleshooting procedure

When a trouble occurred, check the parts along with the following procedure.



NOTE

For cause of a trouble, power conditions or malfunction/erroneous diagnosis of microcomputer due to outer noise is considered except the items to be checked. If there is any noise source, change the wires of the remote controller to shield wires.

<Wireless remote controller type>

1. Before troubleshooting

1) Required tools/instruments

- ⊕ and ⊖ screwdrivers, spanners, radio cutting pliers, nippers, etc.
- Tester, thermometer, pressure gauge, etc.

2) Confirmation points before check

a) The following operations are normal.

1. Compressor does not operate.

- Does not 3-minute delay control work? (3 minutes after compressor stops)
- Is not the indoor unit under thermostat OFF control?
* Thermostat OFF : Indoor unit monitors whether the room temperature reaches setting temperature.
- Is not the remote controller under timer operation or fan mode?
- Is not an overflow trouble of drain water detected on the indoor unit?
- Does not outside high-temperature operation control work in heating operation?

2. Indoor fan does not rotate.

- Does not cool air discharge preventive control work in heating operation?

3) Outdoor fan does not rotate or air volume changes.

- Does not high-temperature release operation control work in heating operation?
- Does not outside low-temperature operation control work in cooling operation?
- Is not defrost operation performed?

4) ON/OFF operation cannot be performed from remote controller.

- Is not forced operation performed?
- Does not the central remote controller or the remote location ON/OFF control work?
- Is not automatic address being set up?
(When the power is turned on at the first time or when indoor unit address setting is changed, the operation cannot be performed for maximum approx. 5 minutes after power-ON.)
- Is not being carried out a test run by operation of the outdoor unit?

5) LED for the indoor unit and outdoor unit communication does not flash.

* LED is on the P.C. board of a outdoor unit.

- Does not standby power saving operation control work?
(LED does not flash, when the indoor unit and outdoor unit communication is being stopped during the standby power saving control. Operating service switches (SW01 or SW02) on the outdoor unit allow to restart the communication.)

a) Did you return the wiring to the initial positions?

b) Are connecting wires between indoor unit and receiving unit correct?

2. Troubleshooting procedure

When a trouble occurred, check the parts along with the following procedure.



NOTE

For cause of a trouble, power conditions or malfunction/erroneous diagnosis of microcomputer due to outer noise is considered except the items to be checked. If there is any noise source, change the wires of the remote controller to shield wires.

Outline of troubleshooting

The primary judgment to check whether a trouble occurred in the indoor unit or outdoor unit is carried out with the following method.

Method to judge the troubleshooting by flashing indication on indoor unit lamp display (the signal receiving unit of wireless remote controller)

When the protective function operates the self-diagnosis contents appear in flashing indication on indoor unit lamp display.

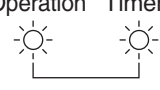
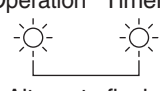
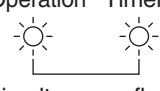
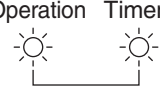
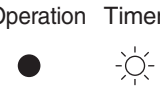
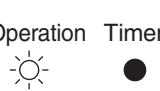
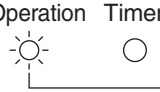

● : Go off, ○ : Go on, ☼ : Flash (0.5 sec.)

Lamp indication	Check code	Cause of trouble occurrence
Operation Timer Ready ● ● ● No indication at all	—	Power supply OFF or miss-wiring between receiving unit and indoor unit
Operation Timer Ready ☼ ● ● Flash	E01	Receiving trouble } Receiving unit } Miss-wiring or wire connection trouble between receiving unit and indoor unit Sending trouble } Communication stop }
	E02	
	E03	
	E08	Duplicated indoor unit No. } Setup trouble Duplicated header units of remote controller }
	E09	
	E10	Communication trouble between CPUs on indoor unit P.C. board
E18	Wire connection trouble between indoor units, Indoor power OFF (Communication stop between indoor header and follower or between header and follower indoor twin)	
Operation Timer Ready ● ● ☼ Flash	E04	Miss-wiring between indoor unit and outdoor unit or connection trouble (Communication stop between indoor and outdoor units)
Operation Timer Ready ● ☼ ☼ Alternate flash	P01	Overflow was detected. } Protective device of indoor unit worked. Indoor DC fan trouble }
	P10	
	P12	
Operation Timer Ready ☼ ● ☼ Alternate flash	P03	Outdoor unit discharge temp. trouble } Protective device of outdoor unit worked. *1 Outdoor high pressure system trouble }
	P04	
	P05	Negative phase detection trouble } Outdoor unit trouble Heat sink overheat trouble } Gas leak detection trouble }
	P07	
	P15	
	P19	4-way valve system trouble (Indoor or outdoor unit judged.)
	P20	Outdoor unit high pressure protection
	P22	Outdoor unit: Outdoor unit trouble } Protective device of outdoor unit worked. *1 Outdoor unit: Inverter Idc operation } Outdoor unit: Position detection trouble }
	P26	
	P29	
P31	Stopped because of trouble of other indoor unit in a group (Check codes of E03/L03/L07/L08)	

Lamp indication	Check code	Cause of trouble occurrence
Operation Timer Ready  Alternate flash	F01	Heat exchanger sensor (TCJ) trouble Heat exchanger sensor (TC) trouble Heat exchanger sensor (TA) trouble } Indoor unit sensor trouble
	F02	
	P10	
Operation Timer Ready  Alternate flash	F04	Discharge temp. sensor (TD) trouble Temp. sensor (TE) trouble Temp. sensor (TL) trouble Temp. sensor (TO) trouble Temp. sensor (TS) trouble Temp. sensor (TH) trouble Temp. sensor miss-wiring (TE, TS) } Sensor trouble of outdoor unit *1
	F06	
	F07	
	F08	
	F12	
	F13	
	F15	
Operation Timer Ready  Simultaneous flash	F29	Indoor EEPROM trouble
Operation Timer Ready  Simultaneous flash	F31	Outdoor EEPROM trouble
Operation Timer Ready  Flash	H01	Compressor break down Compressor lock Current detection circuit trouble Case thermostat worked. PS pressure sensor trouble low pressure protective operation } Outdoor compressor system trouble *1 } Power supply, outdoor P.C. board trouble } Compressor overheat, outdoor wiring trouble Outdoor unit low pressure system trouble
	H02	
	H03	
	H04	
	H06	
Operation Timer Ready  Simultaneous flash	L03	Duplicated header indoor units There is indoor unit of group connection in individual indoor unit. Unsetting of group address Missed setting (Unset indoor capacity) } → AUTO address } * If group construction and address are not normal when power supply turned on, automatically goes to address setup mode.
	L07	
	L08	
	L09	
Operation Timer Ready  Simultaneous flash	L10	Unset model type (Service board)
	L20	Duplicated indoor central addresses
	L29	Outdoor unit and other trouble
	L30	Outside interlock trouble
	L31	Negative phase trouble

*1: These are representative examples and the check code differs according to the outdoor unit to be combined.

Others (Other than Check Code)

Lamp indication	Check code	Cause of trouble occurrence
Operation Timer Ready  Simultaneous flash	—	During test run
Operation Timer Ready  Alternate flash	—	Disagreement of cool/heat (Automatic cool/heat setting to automatic cool/heat prohibited model, or setting of heating to cooling-only model)

8-1-1. Monitor Function of Remote Controller

■ Calling of sensor temperature display

<Contents>

Each data of the remote controller, indoor unit and outdoor unit can be understood by calling the service monitor mode from the remote controller.

<Procedure>

1 Push **TEST** + **CL** buttons simultaneously for 4 seconds to call the service monitor mode.

The service monitor goes on, the header indoor unit No. is displayed at first and then the temperature of CODE No. 00 is displayed.



2 Push temperature set **TEMP.** buttons and then change the CODE No. of data to be monitored.

The CODE No. list is shown below.

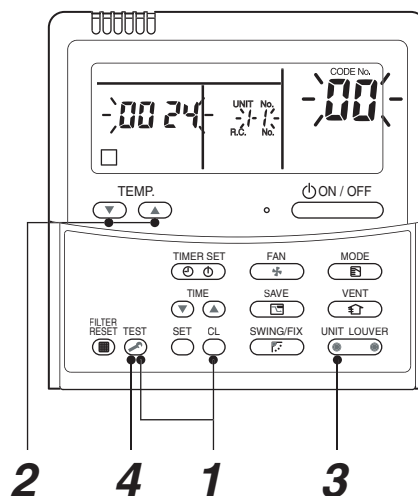

<Operation procedure>

1 → 2 → 3 → 4

Returned to usual display

	CODE No.	Data name	Unit
Indoor unit data	01	Room temperature (Remote controller)	°C
	02	Indoor suction temperature (TA)	°C
	03	Indoor heat exchanger (Coil) temperature (TCJ)	°C
	04	Indoor heat exchanger (Coil) temperature (TC)	°C
	07	Indoor fan revolution frequency	rpm
	F2	Indoor fan calculated operation time	×100h
	F3	Indoor unit fan cumulative operating hours	×1h
	F8	Indoor discharge temperature	°C

	CODE No.	Data name	Unit
Outdoor unit data	60	Outdoor heat exchanger (Coil) temperature (TE)	°C
	61	Outside temperature (TO)	°C
	62	Compressor discharge temperature (TD)	°C
	63	Compressor suction temperature (TS)	°C
	65	Heat sink temperature (THS)	°C
	6A	Operation current (× 1/10)	A
	6D	Outdoor heat exchanger (Coil) temperature (TL)	°C
	70	Compressor operation frequency	rps
	72	Outdoor fan revolution frequency (Lower)	rpm
	73	Outdoor fan revolution frequency (Upper)	rpm
	F1	Compressor calculated operation time	×100h



3 Push **UNIT LOUVER** button to select the indoor unit to be monitored. Each data of the indoor unit and its outdoor units can be monitored.



4 Pushing **TEST** button returns the status to the usual display.

*1 The indoor discharge temperature of CODE No. [F8] is the estimated value from TC or TCJ sensor. Use this value to check discharge temperature at test run. (A discharge temperature sensor is not provided to this model.)

- The data value of each item is not the real time, but value delayed by a few seconds to ten-odd seconds.

Check Code List (Outdoor)

ALT (Alternate); Alternate flashing when there are two flashing LED SIM (Simultaneous); Simultaneous flashing when there are two flashing LED

○: Go on, ⊙: Flash, ●: Go off

Remote controller indication	Sensor lamp part		Representative trouble position	Detection	Explanation of trouble contents	Automatic reset	Operation continuation
	Block indication	Flash					
F04	⊙	⊙	Outdoor unit Discharge temp. sensor (TD) trouble	Outdoor	Open/Short of discharge temp. sensor was detected.	X	X
F06	⊙	⊙	Outdoor unit Temp. sensor (TE, TS, TL) trouble	Outdoor	Open/Short of heat exchanger temp. sensor was detected. Miss-wiring between TE sensor and TS sensor	X	X
F08	⊙	⊙	Outdoor unit Outside temp. sensor (TO) trouble	Outdoor	Open/Short of outside temp. sensor was detected.	O	O
F07	⊙	⊙	Outdoor unit Temp. sensor (TL) trouble	Outdoor	Open/Short of heat exchanger temp. sensor was detected.	X	X
F12	⊙	⊙	Outdoor unit Temp. sensor (TS) trouble	Outdoor	Open/Short of suction temp. sensor was detected.	X	X
F13	⊙	⊙	Outdoor unit Temp. sensor (TH) trouble	Outdoor	Open/Short of heat sink temp. sensor (Board installed) was detected.	X	X
F15	⊙	⊙	Outdoor unit Misconnection of temp. sensor (TE, TS)	Outdoor	Misconnection of outdoor heat exchanger temp. sensor and suction temp. sensor was detected.	X	X
F31	⊙	⊙	Outdoor unit EEPROM trouble	Outdoor	Outdoor P.C. board part (EEPROM) trouble was detected.	X	X
H01	●	●	Outdoor unit Compressor break down	Outdoor	When reached min-Hz by current release control, short-circuited current (I _{dc}) after DC excitation was detected.	X	X
H02	●	●	Outdoor unit Compressor lock	Outdoor	Compressor lock was detected.	X	X
H03	●	●	Outdoor unit Current detection circuit trouble	Outdoor	Current detection circuit trouble	X	X
H04	●	●	Outdoor unit Case thermostat operation	Outdoor	Case thermostat operation was detected.	X	X
L10	○	○	Outdoor unit Setting trouble of service P.C. board type	Outdoor	When outdoor service P.C. board was used, model type select jumper setting was inappropriate.	X	X
L29	○	○	Outdoor unit Other outdoor unit trouble	Outdoor	1) Trouble parts on outdoor P.C. board (MCU communication, EEPROM, TH sensor trouble) 2) When outdoor service P.C. board was used, model type selection was inappropriate. 3) Other trouble (Heat sink abnormal overheat, gas leak, 4-way valve inverse trouble) was detected.	X	X
P03	⊙	⊙	Outdoor unit Discharge temp. trouble	Outdoor	Trouble was detected by discharge temp. release control.	X	X
P04	⊙	⊙	Outdoor unit High pressure system trouble, Power supply voltage trouble	Outdoor	When case thermostat worked, trouble was detected by high release control from indoor/outdoor heat exchanger temp. sensor. Power supply voltage trouble	X	X
P05	⊙	⊙	Power supply trouble	Outdoor	Power supply voltage trouble	X	X
P07	⊙	⊙	Outdoor unit Heat sink overheat	Outdoor	Abnormal overheat was detected by outdoor heat sink temp. sensor.	X	X
P15	⊙	⊙	Gas leak detection	Outdoor	Abnormal overheat of discharge temp. or suction temp. was detected.	X	X
P20	⊙	⊙	Outdoor unit High pressure system trouble	Outdoor	Trouble was detected by high release control from indoor/outdoor heat exchanger temp. sensor.	X	X
P22	⊙	⊙	Outdoor unit Outdoor fan trouble	Outdoor	Trouble (Over-current, lock, etc.) was detected on outdoor fan drive circuit.	X	X
P26	⊙	⊙	Outdoor unit Inverter Idc operation	Outdoor	Short-circuited protective operation of compressor drive circuit element (IPM) worked.	X	X
P29	⊙	⊙	Outdoor unit Position detection trouble	Outdoor	Position detection trouble of compressor motor was detected.	X	X
E01	⊙	●	No remote controller header unit Remote controller communication trouble	Remote controller	Signal was not received from indoor unit. Main remote controller was not set. (including 2 remote controllers)	—	—
E02	⊙	●	Remote controller send trouble	Remote controller	Signal cannot be sent to indoor unit.	—	—
E03	⊙	●	Regular communication trouble between indoor and remote controller	Indoor	No communication from remote controller and network adapter	O	X
E04	●	●	Indoor/Outdoor serial trouble	Indoor	Serial communication trouble between indoor and outdoor	O	X
E08	⊙	●	Duplicated indoor addresses	Indoor	Same address as yours was detected.	O	O
E09	⊙	●	Duplicated main remote controllers	Remote controller	In 2-remote controller control, both were set as header. (Indoor header unit stops warning and follower unit continues operation.)	X	X
E10	⊙	●	Communication trouble between CPU and follower indoor units	Indoor	MCU communication trouble between main motor and micro computer	O	△
E18	⊙	●	Regular communication trouble between header and follower indoor units	Indoor	Regular communication was impossible between header and follower indoor units. Communication between twin header (Main unit) and follower (sub unit) was impossible.	O	X
L03	⊙	●	Duplicated indoor header units	Indoor	There are multiple header units in a group.	X	X
L07	⊙	●	There is group cable in individual indoor unit.	Indoor	When even one group connection indoor unit exists in individual indoor unit.	X	X
L08	⊙	●	Unset indoor group address	Indoor	Indoor address group was unset.	X	X
L09	⊙	●	Unset indoor capacity	Indoor	Capacity of indoor unit was unset.	X	X
L30	⊙	○	Outside trouble input to indoor unit (Interlock)	Indoor	Abnormal stop by CN80 outside trouble input	X	X
P19	⊙	●	4-way valve inverse trouble	Indoor Outdoor	In heating operation, trouble was detected by temp. down of indoor heat exchanger or temp. up of TE, TS.	O	X

◇ When this warning was detected before group construction/address check finish at power supply was turned on, the mode shifts automatically to AUTO address setup mode.

ALT (Alternate): Alternate flashing when there are two flashing LED SIM (Simultaneous): Simultaneous flashing when there are two flashing LED

○: Go on, ⊙: Flash, ●: Go off

Remote controller indication	Sensor lamp part			Representative trouble position	Detection	Explanation of trouble contents	Automatic reset	Operation continuation
	Block indication	Timer	Ready					
F01	⊙	⊙	●	Indoor unit Heat exchanger sensor (TC-J) trouble	Indoor	Open/Short of heat exchanger (TC-J) was detected.	○	×
F02	⊙	⊙	●	Indoor unit Heat exchanger sensor (TC) trouble	Indoor	Open/Short of heat exchanger (TC) was detected.	○	×
F10	⊙	⊙	●	Indoor unit Room temp. sensor (TA) trouble	Indoor	Open/Short of room temp. (TA) was detected.	○	×
F29	⊙	⊙	●	Indoor unit Other indoor P.C. board trouble	Indoor	EEPROM trouble (Other trouble may be detected. If no trouble, automatic address is repeated.)	×	×
P01	⊙	⊙	⊙	Indoor unit Indoor fan trouble	Indoor	Indoor AC fan trouble was detected. (Fan thermal relay worked.)	×	×
P10	●	⊙	⊙	Indoor unit Overflow detection	Indoor	Float switch worked.	×	×
P12	●	⊙	⊙	Indoor unit Indoor fan trouble	Indoor	Indoor fan trouble (Over-current / Lock, etc.) was detected.	×	×
P31	⊙	●	⊙	Other indoor unit trouble	Indoor	Other indoor under condition of warning in group. E03/L07/L03/L08 warning	○	×
—	By unit with warning No.			Trouble in indoor group	Network adapter	Sub remote controller trouble in a group (Details of remote controller are displayed with unit No. Only central control side is displayed.)	—	—
—	—	—	—	LAN system communication trouble	Network adapter/Center	Communication trouble of central control system signal * Is not displayed on the remote controller	○	○
L20	⊙	○	⊙	LAN system communication trouble	Network adapter/Center	Duplicated indoor address of central control system communication	○	×
—	—	—	—	There are multiple communication adapters.	Network adapter	There are multiple communication adapters on remote controller communication line.	○	○

Check code table

The contents of trouble detected by indoor unit

Operation of diagnostic function				Judgment and measures
Check code	Cause of operation	Status of air conditioner	Condition	
E03	No communication from remote controller (including wireless) and communication adapter	Stop (Automatic reset)	Displayed when trouble is detected	1. Check cables of remote controller and communication adapters. • Remote controller LCD display OFF (Disconnection) • Central remote controller [97] check code
E04	The serial signal is not output from outdoor unit to indoor unit. • Miss-wiring of inter-unit wire • Trouble serial sending circuit on outdoor P.C. board • Trouble serial receiving circuit on indoor P.C. board	Stop (Automatic reset)	Displayed when trouble is detected	1. Outdoor unit does not completely operate. • Inter-unit wire check, correction of miss-wiring. • Check outdoor P.C. board. Correct wiring of P.C. board. 2. When outdoor unit normally operates Check P.C. board (Indoor receiving / Outdoor sending).
E08	Duplicated indoor unit address	Stop	Displayed when trouble is detected	1. Check whether remote controller connection (Group/Individual) was changed or not after power supply turned on (Finish of group construction/Address check). * If group construction and address are not normal when the power has been turned on, the mode automatically shifts to address setup mode. (Resetting of address)
L03	Duplicated indoor header unit			
L07	There is group wire in individual indoor unit.			
L08	Unset indoor group address			
L09	Unset indoor capacity	Stop	Displayed when trouble is detected	1. Set indoor capacity (DN=11)
L30	Abnormal input of outside interlock	Stop	Displayed when trouble is detected	1. Check outside devices. 2. Check indoor P.C. board.
P10	Float switch operation • Float circuit, Disconnection, Coming-off, Float switch contact trouble	Stop	Displayed when trouble is detected	1. Trouble of drain pump 2. Clogging of drain pump 3. Check float switch. 4. Check indoor P.C. board.
P12	Indoor DC fan trouble	Stop	Displayed when trouble is detected	1. Position detection trouble 2. Over-current protective circuit of indoor fan driving unit operated. 3. Indoor fan locked. 4. Check indoor P.C. board.
P19	4-way valve system trouble • After heating operation has started, indoor heat exchangers temp. is down.	Stop (Automatic reset)	Displayed when trouble is detected	1. Check 4-way valve. 2. Check indoor heat exchanger (TC/TCJ). 3. Check indoor P.C. board.
P31	Unit automatically stops while warning is output to other indoor units.	Stop (Follower unit) (Automatic reset)	Displayed when trouble is detected	1. Judge follower unit while header unit is [E03], [L03], [L07] or [L08]. 2. Check indoor P.C. board.
F01	Coming-off, disconnection or short of indoor heat exchanger temp. sensor (TCJ)	Stop (Automatic reset)	Displayed when trouble is detected	1. Check indoor heat exchanger temp. sensor (TCJ). 2. Check indoor P.C. board.
F02	Coming-off, disconnection or short of indoor heat exchanger temp. sensor (TC)	Stop (Automatic reset)	Displayed when trouble is detected	1. Check indoor heat exchanger temp. sensor (TC). 2. Check indoor P.C. board.
F10	Coming-off, disconnection or short of indoor heat exchanger temp. sensor (TA)	Stop (Automatic reset)	Displayed when trouble is detected	1. Check indoor heat exchanger temp. sensor (TA). 2. Check indoor P.C. board.
F29	Indoor EEPROM trouble • EEPROM access trouble	Stop (Automatic reset)	Displayed when trouble is detected	1. Check indoor EEPROM. (including socket insertion) 2. Check indoor P.C. board.
E10	Communication trouble between indoor MCU • Communication trouble between fan driving MCU and main MCU	Stop (Automatic reset)	Displayed when trouble is detected	1. Check indoor P.C. board.
E18	Regular communication trouble between indoor master and follower units and between main and sub units	Stop (Automatic reset)	Displayed when trouble is detected	1. Check remote controller wiring. 2. Check indoor power supply wiring. 3. Check indoor P.C. board.

Operation of diagnostic function				Judgment and measures
Check code	Cause of operation	Status of air conditioner	Condition	
Indoor unit				
F04	Disconnection, short of discharge temp. sensor (TD)	Stop	Displayed when trouble is detected	1. Check discharge temp. sensor (TD). 2. Check outdoor P.C. board (MCC-1599).
F06	Disconnection, short of outdoor temp. sensor (TE)	Stop	Displayed when trouble is detected	1. Check temp. sensor (TE). 2. Check outdoor P.C. board (MCC-1599).
F07	Disconnection, short of outdoor temp. sensor (TL)	Stop	Displayed when trouble is detected	1. Check temp. sensor (TL). 2. Check outdoor P.C. board (MCC-1599).
F12	Disconnection, short of suction temp. sensor (TS)	Stop	Displayed when trouble is detected	1. Check suction temp. sensor (TS). 2. Check outdoor P.C. board (MCC-1599).
F15	Miss-mounting of outdoor temp. sensor (TE, TS)	Stop	Displayed when trouble is detected	1. Check temp. sensor (TE, TS). 2. Check outdoor P.C. board (MCC-1599).
F08	Disconnection, short of outside temp. sensor (TO)	Continue	Displayed when trouble is detected	1. Check outside temp. sensor (TO). 2. Check outdoor P.C. board (MCC-1599).
F13	Disconnection, short of heat sink temp. sensor (TH)	Stop	Displayed when trouble is detected	1. Check outdoor P.C. board (MCC-1599). (Q201 is incorporated in TH sensor.)
F31	Outdoor P.C. EEPROM trouble	Stop	Displayed when trouble is detected	1. Check outdoor P.C. board (MCC-1599).
L10	Unset jumper of service P.C. board	Stop	Displayed when trouble is detected	1. Outdoor service P.C. board Check model type setting jumper wire.
L29	Communication trouble between outdoor P.C. board MCU	Stop	Displayed when trouble is detected	1. Check outdoor P.C. board (MCC-1596, MCC-1597, MCC-1599). 2. Connection check between CN802 of MCC-1599 and CN504 of MCC-1597, and also connection check between CN505 of MCC-1597 and CN851 of MCC-1596.
P07	Heat sink overheat trouble * Heat sink temp. sensor detected over specified temperature.	Stop	Displayed when trouble is detected	1. Check screw tightening between PC. Board and heat sink and check radiator grease (MCC-1599). 2. Check heat sink blast path.
P15	Detection of gas leak * Discharge temp. sensor (TD), Suction temp. sensor (TS) detected temperature over specified temp.	Stop	Displayed when trouble is detected	1. Check gas leak, recharge 2. Check full open of service valve. 3. Check PMV (Pulse Motor Valve). 4. Check broken pipe. 5. Check discharge temp. sensor (TD), suction temp. sensor (TS).
P19	4-way valve inverse trouble * After heating operation has started, indoor heat exchanger temp. lowers under the specified temp. * After heating operation has started, outdoor heat exchanger / suction temp. rises over the specified temp.	Stop	Displayed when trouble is detected	1. Check operation of 4-way valve. 2. Check outdoor heat exchanger (TE), suction temp. sensor (TS). 3. Check indoor heat exchanger sensor (TC). 4. Check 4-way valve coil. 5. Check PMV (Pulse Motor Valve).
H01	Compressor break down * Although operation has started, operation frequency decreases and operation stops.	Stop	Displayed when trouble is detected	1. Check power supply voltage. (AC342 to 457V) 2. Overload operation of refrigerating cycle
H02	Compressor lock * Over-current detection after compressor start-up	Stop	Displayed when trouble is detected	1. Trouble of compressor (Lock, etc.): Replace compressor. 2. Wiring trouble of compressor (Open phase)
H03	Current detection circuit trouble	Stop	Displayed when trouble is detected	1. Check outdoor P.C. board (MCC-1599). (AC current detection circuit)
F23	Ps sensor trouble	Stop	Displayed when trouble is detected	1. Check connection of Ps sensor connector. 2. Check failure of Ps sensor. 3. Check compressing power trouble of compressor. 4. Check 4-way valve trouble. 5. Check outdoor P.C. board trouble.

Operation of diagnostic function				Judgment and measures
Check code	Cause of operation	Status of air conditioner	Condition	
Indoor unit				
P03	Discharge temp. trouble * Discharge temp. (TD) over specified value was detected.	Stop	Displayed when trouble is detected	1. Check refrigerating cycle (Gas leak) 2. Trouble of electronic expansion valve 3. Check discharge temp. sensor (TD).
H04	Case thermostat operation * Abnormal overheat of compressor	Stop	Displayed when trouble is detected	1. Check case thermostat and connector. 2. Check gas leak, recharge 3. Check full open of service valve. 4. Check PMV (Pulse Motor Valve). 5. Check broken pipe.
P04	High pressure SW system trouble	Stop	Displayed when trouble is detected	1. Check service valves are fully opened. (Gas side, Liquid side) 2. Check of outdoor fan operation. 3. Check motor trouble of outdoor fan. 4. Check clogging of outdoor PMV. 5. Check clogging of heat exchanger in indoor/outdoor units. 6. Short-circuit status of suction/discharge air in outdoor unit. 7. Check outdoor P.C. board trouble. 8. Check fan system trouble (Cause of air volume drop) at indoor side. 9. Check PMV opening status in indoor unit.
P05	Power supply voltage trouble	Stop	Displayed when trouble is detected	1. Check power supply voltage. AC342 to 457V
	Open phase of 3-phase power supply	Stop	Displayed when trouble is detected	1. Check open phase of 3-phase power supply. 2. Black lead wire to be connected to CN03 of MCC-1596 does not pass through T611.
	High pressure SW system trouble	Stop	Displayed when trouble is detected	1. Check service valves are fully opened. (Gas side, Liquid side) 2. Check of outdoor fan operation. 3. Check motor trouble of outdoor fan. 4. Check clogging of outdoor PMV. 5. Check clogging of heat exchanger in indoor/outdoor units. 6. Short-circuit status of suction/discharge air in outdoor unit. 7. Check outdoor P.C. board trouble. 8. Check fan system trouble (Cause of air volume drop) at indoor side. 9. Check PMV opening status in indoor unit.
P20	High pressure protective operation * During cooling operation, outdoor temp. sensor (TL) detected temperature over specified temp. * During heating operation, indoor temp. sensor (TC, TCJ) detected temperature over specified temp.	Stop	Displayed when trouble is detected	1. Check outdoor heat exchanger sensor (TL). 2. Check indoor heat exchanger sensor (TC, TCJ). 3. Check full open of service valve. 4. Check indoor/outdoor fan. 5. Check PMV (Pulse Motor Valve). 6. Check clogging and short circuit of indoor/outdoor heat exchanger. 7. Overcharge of refrigerant. Recharge
P22	Outdoor fan system trouble	Stop	Displayed when trouble is detected	1. Check lock of fan motor. 2. Check power supply voltage between L2 and N. AC342 to 457V 3. Check outdoor P.C. board.
P26	Short-circuit trouble of compressor driving element	Stop	Displayed when trouble is detected	1. When performing operation while taking-off compressor wire, P26 trouble occurs. Check control P.C. board (MCC-1599). 2. When performing operation while taking-off compressor wire, an trouble does not occur. (Compressor layer short)
P29	Position detection circuit trouble	Stop	Displayed when trouble is detected	1. Check control P.C. board (MCC-1599).

The contents of trouble detected by remote controller or central controller (TCC-LINK)

Operation of diagnostic function				Judgment and measures
Check code	Cause of operation	Status of air conditioner	Condition	
Not displayed at all (Operation on remote controller is impossible.)	No communication with header indoor unit <ul style="list-style-type: none"> Remote controller wiring is not correct. Power of indoor unit is not turned on. Automatic address cannot be completed. 	Stop	—	Power supply trouble of remote controller, Indoor EEPROM trouble <ol style="list-style-type: none"> Check remote controller inter-unit wiring. Check remote controller. Check indoor power wiring. Check indoor P.C. board. Check indoor EEPROM. (including socket insertion) → Automatic address repeating phenomenon generates.
E01 *2	No communication with header indoor unit <ul style="list-style-type: none"> Disconnection of inter-unit wire between remote controller and header indoor unit (Detected by remote controller side) 	Stop (Automatic reset) * If center exists, operation continues.	Displayed when trouble is detected	Receiving trouble from remote controller <ol style="list-style-type: none"> Check remote controller inter-unit wiring. Check remote controller. Check indoor power wiring. Check indoor P.C. board.
E02	Signal send trouble to indoor unit (Detected by remote controller side)	Stop (Automatic reset) * If center exists, operation continues.	Displayed when trouble is detected	Sending trouble of remote controller <ol style="list-style-type: none"> Check sending circuit inside of remote controller. → Replace remote controller.
E09	There are multiple main remote controllers. (Detected by remote controller side)	Stop (Sub unit continues operation.)	Displayed when trouble is detected	1. In 2-remote controllers (including wireless), there are multiple main units. Check that there are 1 main remote controller and other sub remote controllers.
L20 ----- Central controller L20	Duplicated indoor central addresses on communication of central control system (Detected by indoor/central controller side)	Stop (Automatic reset)	Displayed when trouble is detected	1. Check setting of central control system network address. (Network adapter SW01) 2. Check network adapter P.C. board.
— *3 ----- Central controller (Send) C05 (Receive) C06	Communication circuit trouble of central control system (Detected by central controller side)	Continues (By remote controller)	Displayed when trouble is detected	1. Check communication wire / miss-wiring 2. Check communication (U3, U4 terminals) 3. Check network adapter P.C. board. 4. Check central controller (such as central control remote controller, etc.) 5. Check terminal resistance. (TCC-LINK)
— ----- Central controller P30	Indoor Gr sub unit trouble (Detected by central controller side)	Continuation/Stop (According to each case)	Displayed when trouble is detected	Check the check code of the corresponding unit from remote controller.

*2 The check code cannot be displayed by the wired remote controller.

(Usual operation of air conditioner becomes unavailable.)

For the wireless models, a trouble is notified with indication lamp.

*3 This trouble is related to communication of remote controller (A, B), central system (TCC-LINK U3, U4), and [E01], [E02], [E03], [E09] or [E18] is displayed or no check display on the remote controller according to the contents.

8-2. Diagnostic Procedure for Each Check Code (Outdoor Unit)

- 1) This section describes the diagnostic method for each check code displayed on the remote controller.
- 2) In some cases, a check code indicates multiple symptoms.
In this case, confirm LED display on the outdoor P.C. board to narrow the contents to be confirmed.
- 3) The display on the remote controller may differ from that of LED.
The check code on the remote controller is displayed only when the same trouble occurred continuously by multiple times while LED of the outdoor P.C. board is displayed when a trouble occurred once.

LED display on outdoor P.C. board

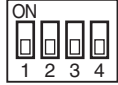
<p>Dip switch setup</p> <ul style="list-style-type: none"> • When turning on 1) only of SW803, the latest trouble is displayed. As the memory is stored, it can be confirmed even if the power supply is turned off once. (excluding outside temp. sensor (TO) trouble) • When the work finished or the outdoor temp. sensor (TO) trouble was found, turn off all of SW803. (The trouble which occurs at present is displayed.) 	<p style="text-align: center;"><Latest trouble display> Only 1) of SW803 is ON.</p> <div style="text-align: center;">  </div> <p style="text-align: center;"><Trouble display, which occurs at present> All SW803 are OFF. (Initial status)</p> <div style="text-align: center;">  </div>																					
<p>Display selection</p> <ul style="list-style-type: none"> • When even a LED of D800 to D804 (Yellow) goes on, trouble occurrence is indicated. <Display 1> • If pushing the button switch SW800 for 1 second under the above condition, the yellow LED is displayed with flashing. <Display 2> • When pushing SW800 for 1 second again, the status returns to <Display 1>. • The trouble contents can be confirmed by combining <Display 1> and <Display 2>. 	<p style="text-align: center;"><Display 1> ↔ <Display 2></p> <table style="width: 100%; border-collapse: collapse;"> <tr> <td style="width: 33%;"></td> <td style="width: 33%; text-align: center;">(No trouble)</td> <td style="width: 33%; text-align: center;">(Trouble occurred) (Push SW800)</td> </tr> <tr> <td>D805 (Green)</td> <td style="text-align: center;">○</td> <td style="text-align: center;">○</td> </tr> <tr> <td>D804 (Yellow)</td> <td style="text-align: center;">●</td> <td style="text-align: center;">○</td> </tr> <tr> <td>D803 (Yellow)</td> <td style="text-align: center;">●</td> <td style="text-align: center;">●</td> </tr> <tr> <td>D802 (Yellow)</td> <td style="text-align: center;">●</td> <td style="text-align: center;">◎</td> </tr> <tr> <td>D801 (Yellow)</td> <td style="text-align: center;">●</td> <td style="text-align: center;">●</td> </tr> <tr> <td>D800 (Yellow)</td> <td style="text-align: center;">●</td> <td style="text-align: center;">●</td> </tr> </table> <p style="text-align: center;">(Example of discharge temp. sensor trouble)</p> <p style="text-align: center;">● : Go off, ○ : Go on, ◎ : Flash</p>		(No trouble)	(Trouble occurred) (Push SW800)	D805 (Green)	○	○	D804 (Yellow)	●	○	D803 (Yellow)	●	●	D802 (Yellow)	●	◎	D801 (Yellow)	●	●	D800 (Yellow)	●	●
	(No trouble)	(Trouble occurred) (Push SW800)																				
D805 (Green)	○	○																				
D804 (Yellow)	●	○																				
D803 (Yellow)	●	●																				
D802 (Yellow)	●	◎																				
D801 (Yellow)	●	●																				
D800 (Yellow)	●	●																				

Check code	Outdoor LED display	Check and troubleshooting (Item without special mention Indicates part of outdoor unit.)
[E04]	—	<p>[Indoor/Outdoor communication trouble]</p> <pre> graph TD Q1{{Is setting of group address of remote controller correct?}} -- NO --> A1[Check CODE No. [14].] Q1 -- YES --> Q2{{Are inner wiring and inter-unit cables (1, 2, 3) normal?}} Q2 -- NO --> A2[Correct wiring and inter-unit cable.] Q2 -- YES --> Q3{{Are connection of CN01 of MCC-1599 and wiring of terminal blocks (1, 2, 3) normal?}} Q3 -- NO --> A3[Correct wiring of connectors and terminal blocks.] Q3 -- YES --> Q4{{Does D502 (Orange LED) flash after power supply is turned on again?}} Q4 -- NO --> A4[Replace indoor P.C. board.] Q4 -- YES --> A5[Replace outdoor P.C. board (MCC-1599).] </pre>

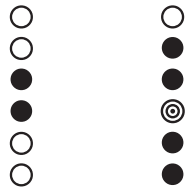
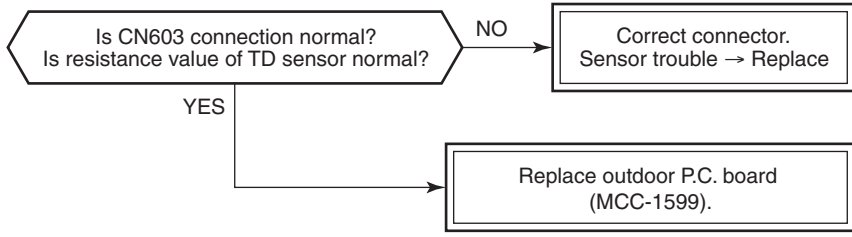
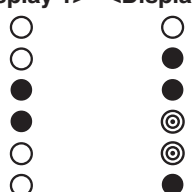
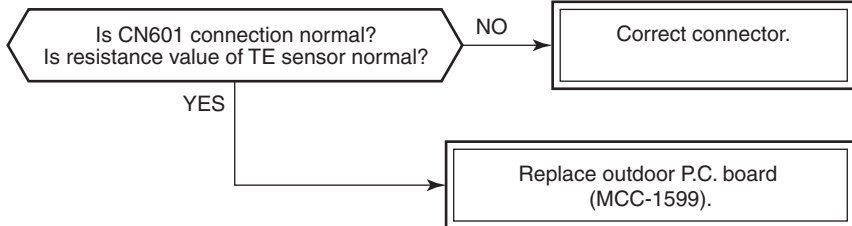
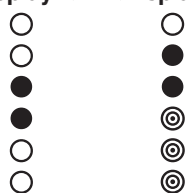
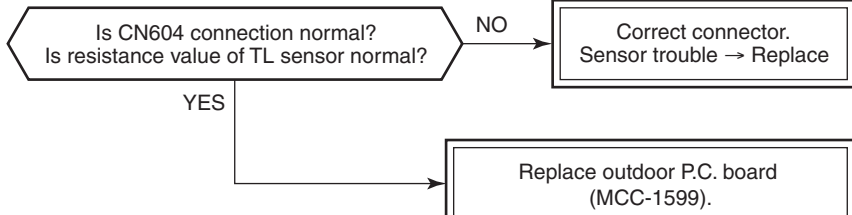
Check code	Outdoor LED display	Check and troubleshooting (Item without special mention indicates part of outdoor unit.)
[F04]	<Display 1> <Display 2> 	[Discharge temp. sensor (TD) trouble] 
[F06]	<Display 1> <Display 2> 	<ul style="list-style-type: none"> There is a possibility that it is one of the following trouble. Confirm LED on outdoor P.C. board to judge which trouble it is. Heat exchanger temp. sensor (TE) trouble, Heat exchanger temp. sensor (TL) trouble, Suction temp. sensor (TS) trouble, Miss-wiring of heat exchanger sensor (TE, TS) [Heat exchanger temp. sensor (TE) trouble]  [Heat exchanger temp. sensor (TL) trouble] → Refer to [F07] column. [Suction temp. sensor (TS) trouble] → Refer to [F12] column. [Miss-wiring of heat exchanger sensor (TE, TS)] → Refer to [F15] column.
[F07]	<Display 1> <Display 2> 	[Heat exchanger temp. sensor (TL) trouble] 

Check code	Outdoor LED display	Check and troubleshooting (Item without special mention indicates part of outdoor unit.)
[F08]	<Display 1> <Display 2> ○ ○ ○ ● ● ◎ ● ● ○ ● ○ ●	[Outside air temp. sensor (TO) trouble] <pre> graph TD Q1{{"Is CN602 connection normal? Is resistance value of TO sensor normal?"}} Q1 -- NO --> A1[Correct connector. Sensor trouble -> Replace] Q1 -- YES --> A2[Replace outdoor P.C. board (MCC-1599).] </pre>
[F12]	<Display 1> <Display 2> ○ ○ ○ ● ● ◎ ● ◎ ○ ● ○ ●	[Suction temp. sensor (TS) trouble] <pre> graph TD Q2{{"Is CN600 connection normal? Is resistance value of TS sensor normal?"}} Q2 -- NO --> A3[Correct connector. Sensor trouble -> Replace] Q2 -- YES --> A4[Replace outdoor P.C. board (MCC-1599).] </pre>
[F13]	<Display 1> <Display 2> ○ ○ ○ ● ● ◎ ● ◎ ○ ● ○ ◎	[Heat sink temp. sensor (TH) trouble] <div style="border: 1px solid black; padding: 5px; width: fit-content; margin: 0 auto;"> Replace outdoor P.C. board (MCC-1599). </div>
[F15]	<Display 1> <Display 2> ○ ○ ○ ● ● ◎ ● ◎ ○ ◎ ○ ◎	[Miss-wiring of heat exchanger sensor (TE, TS)] <pre> graph TD Q3{{"Is mounting status of TE and TS sensors normal?"}} Q3 -- NO --> A5[Correct sensor mounting.] Q3 -- YES --> Q4{{"Is CN600 connection normal? Is resistance value of TS sensor normal?"}} Q4 -- NO --> A6[Correct connector. Sensor trouble -> Replace] Q4 -- YES --> Q5{{"Is CN601 connection normal? Is resistance value of TE sensor normal?"}} Q5 -- NO --> A7[Correct connector. Sensor trouble -> Replace] Q5 -- YES --> A8[Replace outdoor P.C. board (MCC-1599).] </pre>

Check code	Outdoor LED display	Check and troubleshooting (Item without special mention Indicates part of outdoor unit.)
[F31]	<Display 1> <Display 2> ○ ○ ○ ● ● ● ○ ● ○ ● ○ ●	[EEPROM trouble] <div style="border: 1px solid black; padding: 5px; width: fit-content; margin: 0 auto;"> Replace outdoor P.C. board (MCC-1599). </div>
[H01]	<Display 1> <Display 2> ○ ○ ○ ● ● ● ○ ● ● ● ● ● ● ●	[Compressor break down] <div style="display: flex; flex-direction: column; align-items: center;"> <div style="display: flex; align-items: center; margin-bottom: 10px;"> <div style="border: 1px solid black; padding: 5px; width: 200px;">Is power supply voltage normal? AC342 to 457V</div> <div style="margin: 0 10px;">NO</div> <div style="border: 1px solid black; padding: 5px;">Correct power supply line.</div> </div> <div style="margin-bottom: 10px;"> <div style="text-align: center;">YES</div> <div style="border: 1px solid black; padding: 5px; width: 200px;">Is wire connection normal? Compressor lead (Board side, Compressor side), Reactor lead, Power supply lead</div> </div> <div style="display: flex; align-items: center; margin-bottom: 10px;"> <div style="margin: 0 10px;">NO</div> <div style="border: 1px solid black; padding: 5px;">Check wire connection and correct it.</div> </div> <div style="margin-bottom: 10px;"> <div style="text-align: center;">YES</div> <div style="border: 1px solid black; padding: 5px; width: 200px;">Is it not abnormal overload?</div> </div> <div style="display: flex; align-items: center; margin-bottom: 10px;"> <div style="margin: 0 10px;">YES</div> <div style="border: 1px solid black; padding: 5px;">Correct and clear the cause.</div> </div> <div style="margin-bottom: 10px;"> <div style="text-align: center;">NO</div> <div style="border: 1px solid black; padding: 5px; width: 200px;">Replace outdoor P.C. board (MCC-1596).</div> </div> </div>
[H02]	<Display 1> <Display 2> ○ ○ ○ ● ● ● ○ ● ● ● ● ●	[Compressor lock] <div style="display: flex; flex-direction: column; align-items: center;"> <div style="display: flex; align-items: center; margin-bottom: 10px;"> <div style="border: 1px solid black; padding: 5px; width: 200px;">Is power supply voltage normal? AC342 to 457V</div> <div style="margin: 0 10px;">NO</div> <div style="border: 1px solid black; padding: 5px;">Correct power supply line.</div> </div> <div style="margin-bottom: 10px;"> <div style="text-align: center;">YES</div> <div style="border: 1px solid black; padding: 5px; width: 200px;">Is wire connection normal? Compressor lead (Board side, Compressor side), Reactor lead, Power supply lead</div> </div> <div style="display: flex; align-items: center; margin-bottom: 10px;"> <div style="margin: 0 10px;">NO</div> <div style="border: 1px solid black; padding: 5px;">Check wire connection and correct it.</div> </div> <div style="margin-bottom: 10px;"> <div style="text-align: center;">YES</div> <div style="border: 1px solid black; padding: 5px; width: 200px;">Is compressor normal?</div> </div> <div style="display: flex; align-items: center; margin-bottom: 10px;"> <div style="margin: 0 10px;">YES</div> <div style="border: 1px solid black; padding: 5px;">Replace outdoor P.C. board.</div> </div> <div style="margin-bottom: 10px;"> <div style="text-align: center;">NO</div> <div style="border: 1px solid black; padding: 5px; width: 200px;">Is there no refrigerant stagnation?</div> </div> <div style="display: flex; align-items: center; margin-bottom: 10px;"> <div style="margin: 0 10px;">NO</div> <div style="border: 1px solid black; padding: 5px;">Compressor lock → Replace</div> </div> <div style="margin-bottom: 10px;"> <div style="text-align: center;">YES</div> <div style="border: 1px solid black; padding: 5px; width: 200px;">Does PMV normally operate?</div> </div> <div style="display: flex; align-items: center; margin-bottom: 10px;"> <div style="margin: 0 10px;">NO</div> <div style="border: 1px solid black; padding: 5px;">Check TE, TS sensors and PMV. Trouble → Replace</div> </div> <div style="margin-bottom: 10px;"> <div style="text-align: center;">YES</div> <div style="border: 1px solid black; padding: 5px; width: 200px;">Replace outdoor P.C. board (MCC-1596).</div> </div> </div>

Check code	Outdoor LED display	Check and troubleshooting (Item without special mention Indicates part of outdoor unit.)
[H03]	<Display 1> <Display 2> ○ ○ ○ ● ● ● ○ ● ● ◎ ● ◎	[Current detection circuit trouble] <div style="border: 1px solid black; padding: 5px; width: fit-content; margin: auto;"> Replace outdoor P.C. board (MCC-1596). </div>
	<Display 1> <Display 2> ○ ○ ○ ● ● ● ○ ◎ ○ ● ○ ◎	[Power supply trouble (Vdc)] → Refer to [P05] column.
[H04]	<Display 1> <Display 2> ○ ○ ○ ● ● ● ○ ◎ ● ● ● ●	[Case thermostat operation] <pre> graph TD Q1{Are CN609 connection and case thermostat normal?} -- NO --> A1[Correct connector. Case thermostat trouble → Replace] Q1 -- YES --> Q2{Is cooling/heating operation available when short-circuiting case thermostat?} Q2 -- NO --> A2[Replace outdoor P.C. board (MCC-1599).] Q2 -- YES --> Q3{Is there no gas leak? Is it not refrigerant shortage?} Q3 -- NO --> A3[Repair trouble position. Recharge refrigerant.] Q3 -- YES --> Q4{Is valve fully opened?} Q4 -- NO --> A4[Open valve fully.] Q4 -- YES --> Q5{Is PMV normal?} Q5 -- NO --> A5[Replace PMV.] Q5 -- YES --> A6[Check crushed or broken pipe. Trouble → Correct and Replace] </pre>
[L10]	<Display 1> <Display 2> ○ ○ ○ ● ● ◎ ○ ● ○ ◎ ● ●	[Unset model type] : Only when service P.C. board is used <div style="border: 1px solid black; padding: 5px; width: fit-content; margin: auto;"> Cut jumper line according to the explanation sheet packaged with the service P.C. board. </div>

Check code	Outdoor LED display	Check and troubleshooting (Item without special mention indicates part of outdoor unit.)
[L29]		<p>* There is a possibility that it is one of the following trouble. Confirm LED on outdoor P.C. board to judge which trouble it is. Communication trouble between MCU, Heat sink temp. sensor (TH) trouble, EEPROM trouble, Unset model type, Heat sink overheating trouble, Gas leak detection, 4-way valve inverse trouble</p>
	<p><Display 1> <Display 2></p> <p>○ ○ ○ ◎ ● ◎ ○ ◎ ○ ◎ ● ◎</p>	<p>[Communication trouble between MCU]</p> <p>1. Connection check between CN802 of MCC-1599 and CN504 of MCC-1597 and also connection check between CN505 of MCC-1597 and CN851 of MCC-1596. 2. Replace outdoor P.C. board (MCC-1596, MCC-1597, MCC-1599).</p>
	<p><Display 1> <Display 2></p> <p>○ ○ ○ ● ● ◎ ○ ◎ ○ ● ○ ◎</p>	<p>[Heat sink temp. sensor (TH) trouble] → Refer to [F13] column.</p>
	<p><Display 1> <Display 2></p> <p>○ ○ ○ ◎ ● ◎ ○ ◎ ○ ◎</p>	<p>[EEPROM trouble] → Refer to [F31] column.</p>
	<p><Display 1> <Display 2></p> <p>○ ○ ○ ● ○ ◎ ○ ● ● ●</p>	<p>[Unset model type] → Refer to [L10] column.</p>
	<p><Display 1> <Display 2></p> <p>○ ○ ○ ● ○ ● ○ ◎ ○ ◎ ○ ◎</p>	<p>[Heat sink overheating trouble] → Refer to [P07] column.</p>
	<p><Display 1> <Display 2></p> <p>○ ○ ○ ● ○ ◎ ○ ◎ ○ ◎</p>	<p>[Gas leak detection] → Refer to [P15] column.</p>
	<p><Display 1> <Display 2></p> <p>○ ○ ○ ◎ ● ● ○ ● ○ ◎ ○ ◎</p>	<p>[4-way valve inverse trouble] → Refer to [P19] column.</p>

Check code	Outdoor LED display	Check and troubleshooting (Item without special mention indicates part of outdoor unit.)
[P03]	<Display 1> <Display 2> ○ ○ ○ ● ● ● ○ ● ○ ◎ ○ ◎	[Discharge temp. trouble] <pre> graph TD Q1{Is there no gas leak? Is refrigerant charge amount adequate?} -- NO --> A1[Repair trouble position. Recharge refrigerant.] Q1 -- YES --> Q2{Is PMV normal?} Q2 -- NO --> A2[Replace PMV.] Q2 -- YES --> Q3{Is it not abnormal overload?} Q3 -- YES --> A3[Correct and clear the cause.] Q3 -- NO --> Q4{Is CN603 connection normal? Is resistance value of TD sensor normal?} Q4 -- NO --> A4[Correct connector. Sensor trouble → Replace] Q4 -- YES --> A5[Replace outdoor P.C. board (MCC-1599).] </pre>
[P04]	* There is a possibility that it is one of the following trouble. Confirm LED on outdoor P.C. board to judge which trouble it is. (1) high-pressure SW system trouble, (2) power supply trouble (Vdc), (3) high-pressure protective operation, (4) case thermostat operation. <Display 1> <Display 2> ○ ○ ○ ● ● ● ○ ◎ ○ ● ○ ●	[High pressure SW system trouble] Power supply trouble (Vdc), High pressure protective operation, Case thermostat operation. <pre> graph TD Q1{Does high pressure switch operate?} -- NO --> Q2{Is circuit wiring normal?} Q2 -- NO --> A1[Wiring check, Correct.] Q2 -- YES --> Q3{Are parts of high pressure switch normal?} Q3 -- NO --> A2[Parts check Trouble → Replace] Q3 -- YES --> Q4{Is service valve fully opened?} Q4 -- NO --> A3[Open service valve fully.] Q4 -- YES --> A4[Reset the power supply and then do a trial operation according to the season.] A4 --> B[Ⓑ Cooling operation.] A4 --> C[Ⓒ Heating operation.] B --> Q5{Does cooling outdoor fan normally operate?} C --> Q6{Is there no fan breakage or coming-off?} Q5 -- YES --> Q7{Is there any element which blocks heat exchanger of the outdoor unit? ① Clogging of heat exchanger ② Short circuit} Q7 -- YES --> A5[Elimination of blocking element] Q7 -- NO --> A6[Overcharge of refrigerant/ Clogging/Pipe breakage/ Abnormal overload] Q6 -- YES --> A6 Q6 -- NO --> A7[Replace Comp. IPDU P.C. board] A1 --> A7 A2 --> A7 A3 --> A7 A4 --> A7 </pre>

Check code	Outdoor LED display	Check and troubleshooting (Item without special mention indicates part of outdoor unit.)
[P04]		<pre> graph TD Start((C)) --> Heating[Heating operation] Heating --> Fan{Does the heating indoor fan normally operate?} Fan -- NO --> Conn{Are connections of connectors, capacitors and fan motor normal?} Fan -- YES --> HeatEx{Is there any element which blocks indoor heat exchanger? ① Filter clogging ② Clogging of heat exchanger ③ Short circuit} Conn -- NO --> Repair[Repair trouble position.] Conn -- YES --> HeatEx HeatEx -- YES --> Elim[Elimination of blocking element] HeatEx -- NO --> Clog[Clogging by refrigerant overcharge/Pipe breakage/Abnormal overload] Clog --> Sensor{Are characteristics of TC and TCJ sensor resistance value normal?} Sensor -- YES --> PCB[Replace indoor P.C. board.] Sensor -- NO --> Replace[Replace TC or TCJ sensor.] </pre>
	<p><Display 1> <Display 2></p> <p>○ ○</p> <p>○ ○</p> <p>● ●</p> <p>○ ◎</p> <p>● ●</p> <p>● ●</p>	[Case thermostat operation] → Refer to [H04] column.
	<p><Display 1> <Display 2></p> <p>○ ○</p> <p>○ ●</p> <p>● ●</p> <p>○ ◎</p> <p>○ ●</p> <p>○ ◎</p>	[Power supply trouble (Vdc)] → Refer to [P05] column.
	<p><Display 1> <Display 2></p> <p>○ ○</p> <p>○ ◎</p> <p>● ●</p> <p>○ ◎</p> <p>○ ●</p> <p>○ ●</p>	[High pressure protective operation] → Refer to [P20] column.

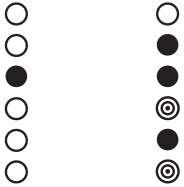
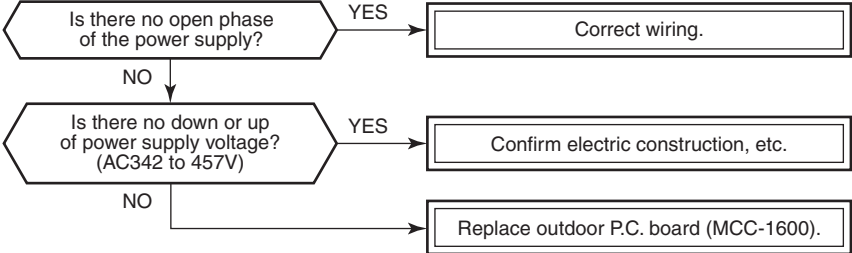
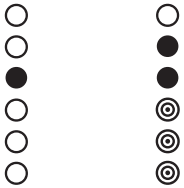
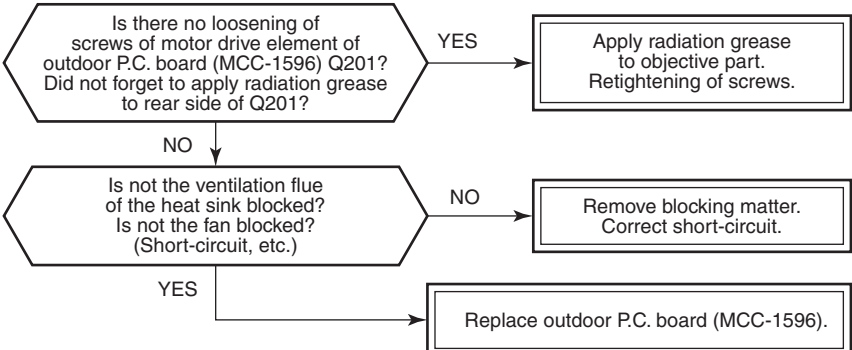
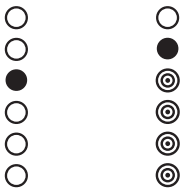
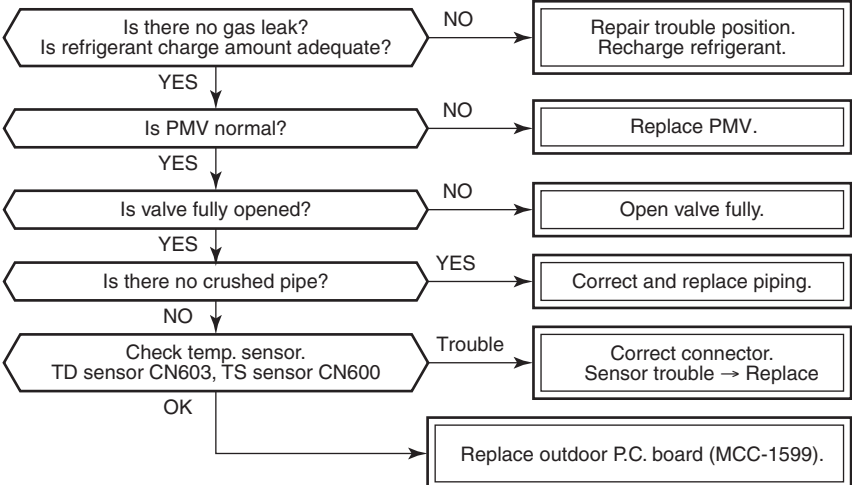
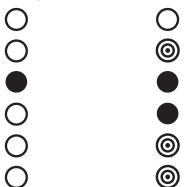
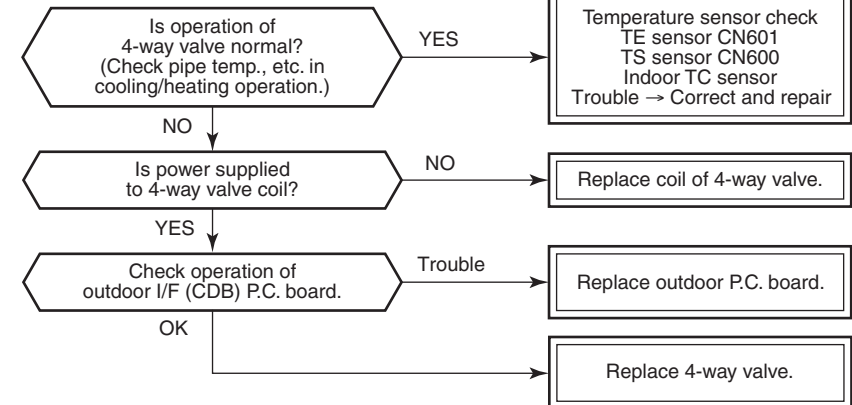
Check code	Outdoor LED display	Check and troubleshooting (Item without special mention indicates part of outdoor unit.)
[P05]	<Display 1> <Display 2> 	[Power supply trouble (Voltage trouble)] 
[P07]	<Display 1> <Display 2> 	[Heat sink overheat trouble] 
[P15]	<Display 1> <Display 2> 	[Gas leak detection] 
[P19]	<Display 1> <Display 2> 	[4-way valve inverse trouble] 

Check code	Outdoor LED display	Check and troubleshooting (Item without special mention indicates part of outdoor unit.)
[P22]	<Display 1> <Display 2> ○ ○ ○ ⊙ ● ● ○ ⊙ ○ ⊙ ○ ●	<p>[Fan system trouble]</p> <pre> graph TD Q1{{Is there no problem on power supply voltage? (342 to 457V)}} Q2{{Does the fan rotate without trouble when rotating shaft of fan motor with hands during power-OFF? Is there no problem on coil resistance of fan motor? Between red and white lead wire : 12 to 20Ω Between white and black lead wire : 12 to 20Ω Between black and red lead wire : 12 to 20Ω}} A1[Check wiring construction. Ask repair of power supply.] A2[Replace fan motor.] A3[Replace outdoor P.C. board (MCC-1597).] Q1 -- NO --> A1 Q1 -- YES --> Q2 Q2 -- YES --> A3 Q2 -- NO --> A2 </pre> <p>Single operation check for outdoor fan</p> <ol style="list-style-type: none"> Set SW804 of Dip switch as the following figure and then push SW801 for approx. 1 second to check single operation of outdoor fan. Use this method to check which fan, upper or lower fan, has a trouble. <ul style="list-style-type: none"> When pushing SW801 for 1 second again or 2 minutes passed, the fan stops. After check, turn off all Dip switch SW804. <div style="border: 1px solid black; padding: 5px; width: fit-content; margin-left: auto;"> <p style="text-align: center;">Outdoor fan single operation</p> <div style="display: flex; justify-content: space-around; align-items: center;"> <div style="text-align: center;"> <p>SW804</p> </div> <div style="text-align: center;"> <p>SW801</p> </div> </div> </div>
[P26]	<Display 1> <Display 2> ○ ○ ○ ⊙ ● ⊙ ○ ● ○ ⊙ ○ ●	<p>[Short-circuit of compressor drive element]</p> <pre> graph TD Q1{{Is there no problem on connection of compressor lead or reactor? (Check referring to Wiring diagram.)}} Q2{{The same trouble does not occur in operation without compressor lead.}} A1[Correct wiring.] A2[Replace outdoor P.C. board.] A3[Check compressor. (layer short, etc.) Trouble → Replace] Q1 -- NO --> A1 Q1 -- YES --> Q2 Q2 -- NO --> A2 Q2 -- YES --> A3 </pre>
[P29]	<Display 1> <Display 2> ○ ○ ○ ⊙ ● ⊙ ○ ⊙ ○ ● ○ ⊙	<p>[Position detection circuit trouble]</p> <div style="border: 1px solid black; padding: 10px; width: fit-content; margin: 0 auto;"> <p style="text-align: center;">Replace outdoor P.C. board (MCC-1596).</p> </div>
— No code	<Display 1> <Display 2> ○ ○ ○ ⊙ ● ⊙ ○ ⊙ ○ ● ● ⊙	<p>[Other trouble] Compressor disorder due to sudden change of load, etc.</p> <ul style="list-style-type: none"> * Although the display of outdoor LED outputs, the unit automatically restarts and trouble is not determined. * LED display also may output due to negative phase of compressor or wire coming-off.

8-3. Sensor characteristics

Temperature – Resistance value characteristic table

TA, TC, TCJ, TE, TS, TO sensors

Representative value

Temperature (°C)	Resistance value (kΩ)		
	(Minimum value)	(Standard value)	(Maximum value)
0	32.33	33.80	35.30
10	19.63	20.35	21.09
20	12.23	12.59	12.95
25	9.75	10.00	10.25
30	7.764	7.990	8.218
40	5.013	5.192	5.375
50	3.312	3.451	3.594
60	2.236	2.343	2.454
70	1.540	1.623	1.709
80	1.082	1.146	1.213
90	0.7740	0.8237	0.8761
100	0.5634	0.6023	0.6434

TD, TL sensors

Representative value

Temperature (°C)	Resistance value (kΩ)		
	(Minimum value)	(Standard value)	(Maximum value)
0	150.5	161.3	172.7
10	92.76	99.05	105.6
20	58.61	62.36	66.26
25	47.01	49.93	52.97
30	37.93	40.22	42.59
40	25.12	26.55	28.03
50	17.00	17.92	18.86
60	11.74	12.34	12.95
70	8.269	8.668	9.074
80	5.925	6.195	6.470
90	4.321	4.507	4.696
100	3.205	3.336	3.468

TA, TC, TCJ, TE, TS, TO sensors

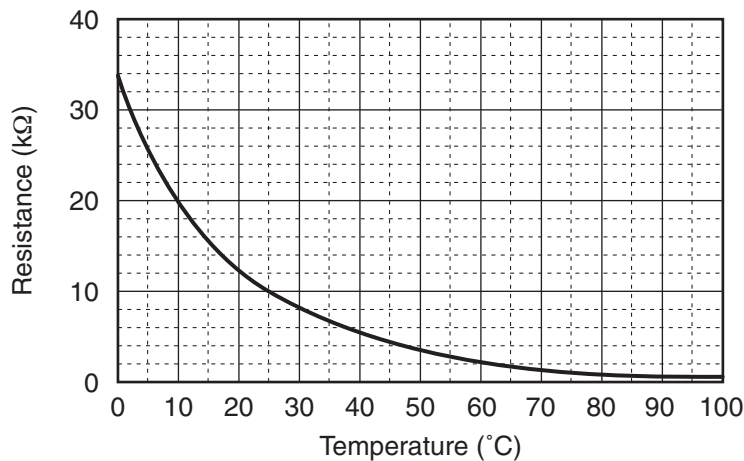

TD, TL sensors

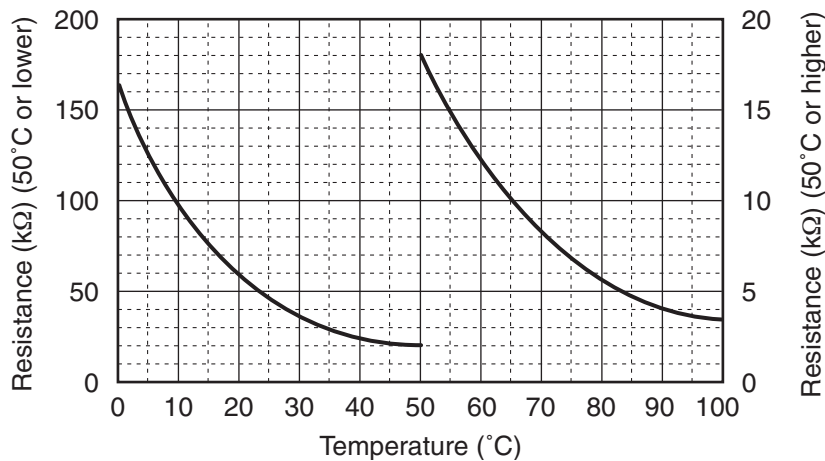

Pressure sensor I/O wire connecting table

Pin No.	Input/output name	Lead wire
1	—	—
2	OUTPUT	White
3	GND	Black
4	DC5V	Red

* As TH sensor (Outdoor unit heat sink temp. sensor) is incorporated in the outdoor control P.C. board, the resistance value cannot be measured.

Table Inspection of outdoor unit main parts

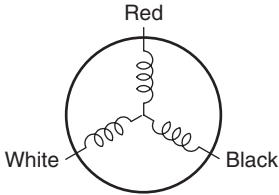
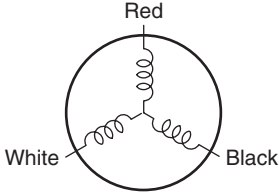
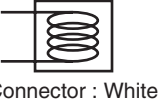
No.	Parts name	Checking procedure										
1	Compressor (Model : RX420A3F-27M)	<p>Measure the resistance value of each winding by using the tester.</p>  <table border="1" data-bbox="892 331 1422 546"> <thead> <tr> <th>Position</th> <th>Resistance value</th> </tr> </thead> <tbody> <tr> <td>Red – White</td> <td rowspan="3">0.79 ± 0.04 Ω</td> </tr> <tr> <td>White – Black</td> </tr> <tr> <td>Black – Red</td> </tr> </tbody> </table> <p style="text-align: right;">Under 20°C</p>	Position	Resistance value	Red – White	0.79 ± 0.04 Ω	White – Black	Black – Red				
Position	Resistance value											
Red – White	0.79 ± 0.04 Ω											
White – Black												
Black – Red												
2	Outdoor fan motor (Model : ICF-280-A100-1)	<p>Measure the resistance value of each winding by using the tester.</p>  <table border="1" data-bbox="892 680 1422 896"> <thead> <tr> <th>Position</th> <th>Resistance value</th> </tr> </thead> <tbody> <tr> <td>Red – White</td> <td rowspan="3">14.8 ± 1.5 Ω</td> </tr> <tr> <td>White – Black</td> </tr> <tr> <td>Black – Red</td> </tr> </tbody> </table> <p style="text-align: right;">Under 20°C</p>	Position	Resistance value	Red – White	14.8 ± 1.5 Ω	White – Black	Black – Red				
Position	Resistance value											
Red – White	14.8 ± 1.5 Ω											
White – Black												
Black – Red												
3	4-way valve coil (Cooling/heating switching) (Model : STF-H01AJ1736A1)	<p>Measure the resistance value of each winding by using the tester.</p>  <p>Connector : White</p> <table border="1" data-bbox="892 1025 1422 1137"> <thead> <tr> <th>Resistance value</th> </tr> </thead> <tbody> <tr> <td>1725 ± 172.5 Ω</td> </tr> </tbody> </table> <p style="text-align: right;">Under 20°C</p>	Resistance value	1725 ± 172.5 Ω								
Resistance value												
1725 ± 172.5 Ω												
4	PMV coil (Model : UKV-A038)	<p>Measure the resistance value of each winding by using the tester.</p> <table border="1" data-bbox="564 1272 1008 1438"> <thead> <tr> <th>Position</th> <th>Resistance value</th> </tr> </thead> <tbody> <tr> <td>Gray – Orange</td> <td>46 ± 3 Ω</td> </tr> <tr> <td>Gray – Yellow</td> <td>46 ± 3 Ω</td> </tr> <tr> <td>Gray – Red</td> <td>46 ± 3 Ω</td> </tr> <tr> <td>Gray – Black</td> <td>46 ± 3 Ω</td> </tr> </tbody> </table> <p style="text-align: right;">Under 20°C</p>	Position	Resistance value	Gray – Orange	46 ± 3 Ω	Gray – Yellow	46 ± 3 Ω	Gray – Red	46 ± 3 Ω	Gray – Black	46 ± 3 Ω
Position	Resistance value											
Gray – Orange	46 ± 3 Ω											
Gray – Yellow	46 ± 3 Ω											
Gray – Red	46 ± 3 Ω											
Gray – Black	46 ± 3 Ω											

9. SETUP AT LOCAL SITE AND OTHERS

9-1. Calling of check Code History

<Contents>

The trouble contents in the past can be called.

<Procedure>

- 1 Push **SET** + **TEST** buttons simultaneously for 4 seconds or more to call the service check mode.

Service Check goes on, the **CODE No. 01** is displayed, and then the content of the latest alarm is displayed. The number and trouble contents of the indoor unit in which a trouble occurred are displayed.

- 2 In order to monitor another check code history, push the set temperature **▼** / **▲** buttons to change the check code history No. (CODE No.).

CODE No. **01** (Latest) → CODE No. **04** (Old)

NOTE : 4 check code histories are stored in memory.

- 3 Pushing **TEST** button returns the display to usual display.

REQUIREMENT

Do not push **CL** button, otherwise all the check code histories of the indoor unit are deleted.

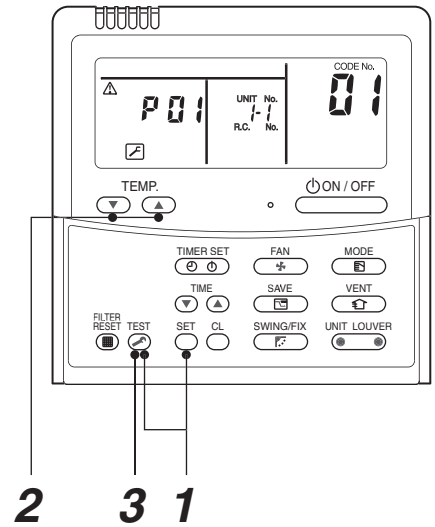

<Operation procedure>

1 → 2 → 3

Returned to usual display

9-2. Group Control Operation

In a group control, operation of maximum 8 indoor units can be controlled by a remote controller.

The indoor unit connected with outdoor unit (Individual/Master of twin) controls room temperature according to setting on the remote controller.

<System example>

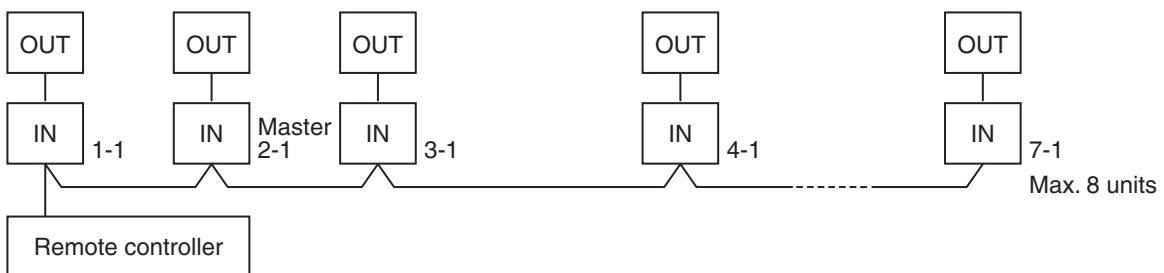

1. Display range on remote controller

The setup range (Operation mode/Air volume select/Setup temp) of the indoor unit which was set to the master unit is reflected on the remote controller.

2. Address setup

Turn on power of the indoor unit to be controlled in a group within 3 minutes after setting of automatic address. If power of the indoor unit is not turned on within 3 minutes (completion of automatic address setting), the system is rebooted and the automatic address setting will be judged again.

- 1) Connect 3 In/Out cables surely.
- 2) Check line address/indoor address/group address of the unit one by one.
- 3) The unit No. (line/indoor gout address) which have been set once keep the present status as a rule if the unit No. is not duplicated with one of another unit.

Indoor unit power-ON sequence

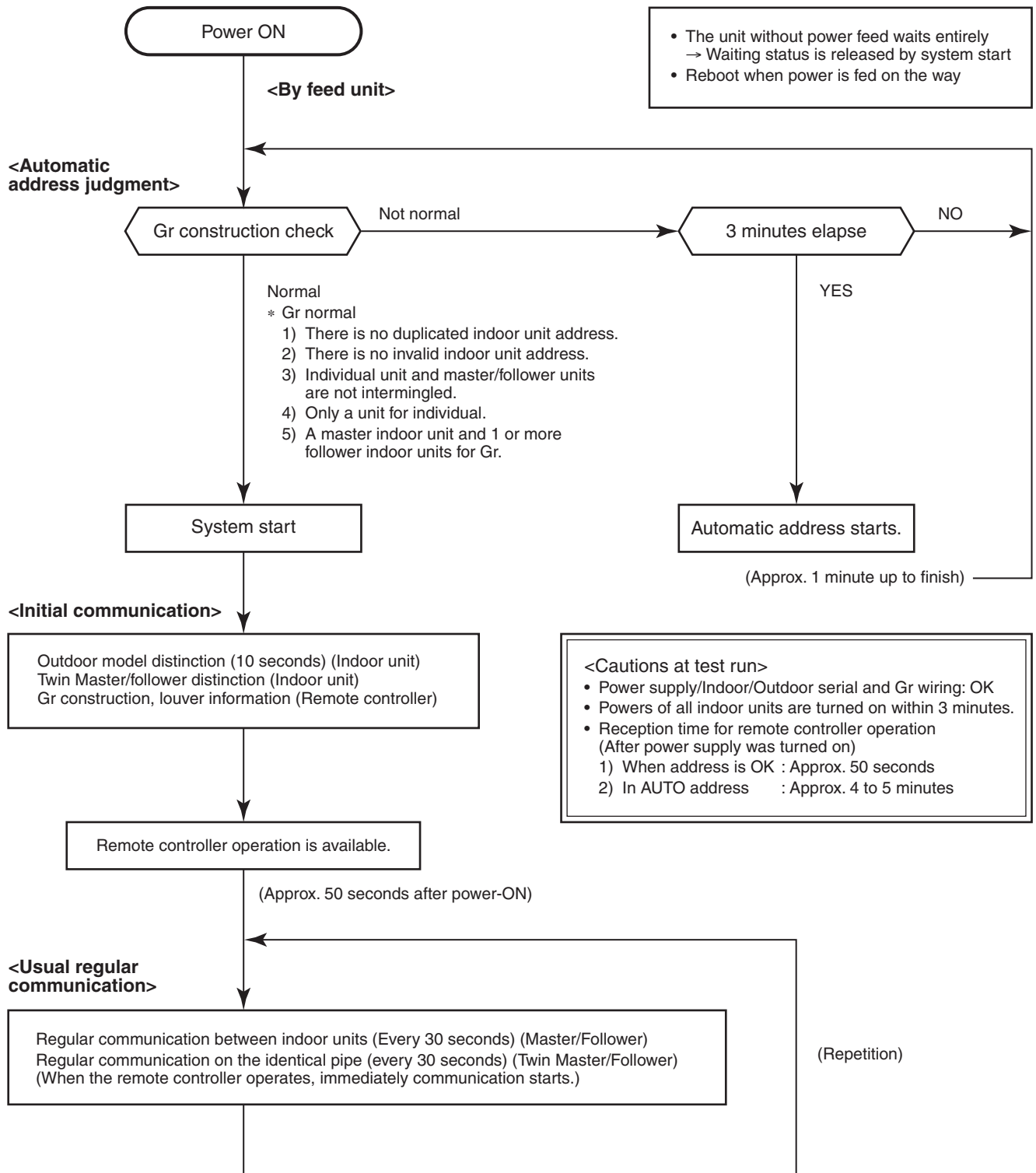

- In a group operation, if the indoor unit which was fed power after judgment of automatic address cannot receive regular communication from the master unit and regular communication on identical pipe within 120 seconds after power was turned on, it reboots (system reset).
→ The operation starts from judgment of automatic address (Gr construction check) again.
(If the address of the master unit was determined in the previous time, the power fed to the master unit and reboot works, the master unit may change though the indoor unit line address is not changed.)

9-3. Outdoor Unit

9-3-1. Various Setting on Outdoor Unit (Existing piping, Power save, Cooling-only, etc.)

The following settings are available by DIP switch setup and jumper line setup.

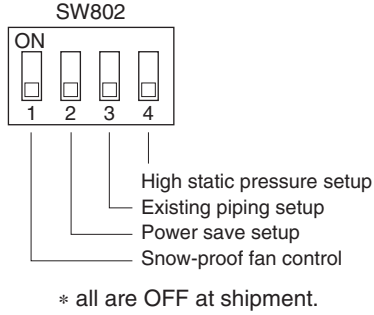
Function	Set position	Control contents																											
High static pressure setup	 <p>SW802</p> <p>ON</p> <p>1 2 3 4</p> <p>High static pressure setup Existing piping setup Power save setup Snow-proof fan control</p> <p>* all are OFF at shipment.</p>	<p>Turn the switch to ON when mounting a duct to the discharge port of the outdoor unit. Add 3 taps to the upper limit value of the outdoor fan tap.</p> <p>The operation is performed with (Max: Upper fan: 890 rpm / Lower fan: 910 rpm (WF)).</p> <p>In this case, the upper limit value of static pressure for duct is 5Pa or less on 25°C degrees and please use straight duct.</p> <p>In this case, the outdoor noise level may increase.</p>																											
Existing piping setup		<p>Turn the switch to ON when Ø19.1 is used for the existing pipe.</p> <p>In this case, the heating capacity may lower according to outside temp. and indoor temp. in heating operation.</p>																											
Power save setup		<p>Turn the switch to ON when using the power save function.</p> <p>The control to lower the compressor frequency (Approx. -10%) is performed by indoor heat exchanger temp. in heating operation.</p>																											
Snow-proof fan control		<p>When snow enters from clearance of the fan guard or heat exchanger into blast path and it is accumulated, the control to prevent generation of motor lock is validated.</p> <p>When outside temp. is below 4°C though the compressor stops, the outdoor fan operates with W5.</p>																											
Defrost time change	J805, J806	<p>The defrost interval is cut to shorten it than the standard status.</p> <p>For contents of control and cutting method, refer to Section 7-10. Defrost control.</p>																											
Max. frequency change	J807	<p>When it is needed to lower the maximum value of the compressor frequency, cut the jumper line. Max. frequency at heating is lowered.</p> <p>In this case the Max. capacity decreases.</p> <p>Max. frequency of compressor</p> <table border="1" data-bbox="769 1391 1430 1547"> <thead> <tr> <th rowspan="2">Model</th> <th colspan="2">GP110</th> <th colspan="2">GP140</th> <th colspan="2">GP160</th> </tr> <tr> <th>COOL</th> <th>HEAT</th> <th>COOL</th> <th>HEAT</th> <th>COOL</th> <th>HEAT</th> </tr> </thead> <tbody> <tr> <td>Standard status</td> <td>53.4</td> <td>100.2</td> <td>64.2</td> <td>100.2</td> <td>74.4</td> <td>100.2</td> </tr> <tr> <td>When J807 is cut</td> <td>53.4</td> <td>69.6</td> <td>64.2</td> <td>75.0</td> <td>74.4</td> <td>79.8</td> </tr> </tbody> </table>	Model	GP110		GP140		GP160		COOL	HEAT	COOL	HEAT	COOL	HEAT	Standard status	53.4	100.2	64.2	100.2	74.4	100.2	When J807 is cut	53.4	69.6	64.2	75.0	74.4	79.8
Model	GP110			GP140		GP160																							
	COOL	HEAT	COOL	HEAT	COOL	HEAT																							
Standard status	53.4	100.2	64.2	100.2	74.4	100.2																							
When J807 is cut	53.4	69.6	64.2	75.0	74.4	79.8																							
Cooling-only setup	J808	<p>When using the air conditioner as a cooling-only conditioner, cut the jumper line. (An air conditioner can be changed to cooling-only conditioner by "0F" of DN code on the remote controller.)</p>																											

9-3-2. Service Support Function (LED Display, Switch Operation)

1. Outline

A various setup and operation check can be performed by DIP switches at 3 positions (SW802, SW803, SW804) and the pushdown button switches (SW800, SW801) at 2 positions.

Operation part

Part No.	Specifications	Operation contents
SW800	Pushdown button switch	Exchanges the displayed contents of LED (D800 to D804) on the outdoor control P.C. board.
SW803	DIP switch	
SW801	Pushdown button switch	Performs the specific operation to check maintenance.
SW804	DIP switch	
SW802	DIP switch	Performs various initial settings. (Refer to 9-3-1.)

Display part

Part No.	Specifications	Operation contents
D502	Orange LED	Indoor/Outdoor communication (Serial communication) signal display (Receive signal from indoor signal)
D503	Green LED	Indoor/Outdoor communication (Serial communication) signal display (Send signal from outdoor signal)
D800 to D804	Yellow LED	Trouble display When all SW803 are OFF, or when any of D800 to D804 goes on, LED displays that the outdoor controller detects a trouble. When status of SW803 is other than OFF, various indications are displayed.
D805	Green LED	Power-ON display When the power of the outdoor unit is turned on, LED goes on. When SW801 and SW804 operate the specific operation, LED flashes.

* All LED are colorless when it goes off.

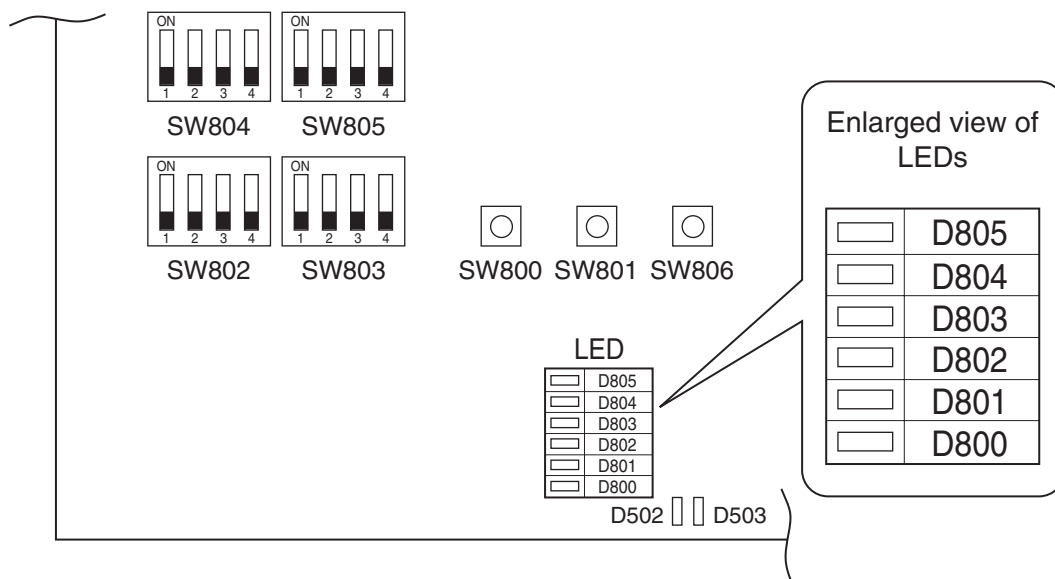





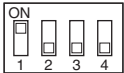
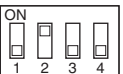

9-3-3. Others

1. Selection of LED display (SW800, SW803 operation)

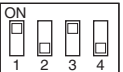
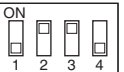
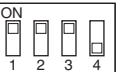
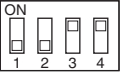
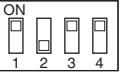
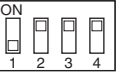
1) Display selection list

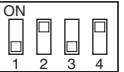
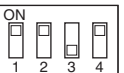
The displayed contents of LED D800 to D804 on the outdoor control P.C. board can be exchanged by operation of SW803.

Switch	Function / Contents	Refer
<p style="text-align: center;">SW803</p> 	<p>Trouble display (Trouble generating at present) Trouble generating at present is displayed. This switch goes off when a trouble does not generate.</p>	<p>Refer to 2)</p>
<p style="text-align: center;">SW803</p> 	<p>Trouble display (The latest trouble: Latest trouble including present) After trouble status was cleared, the trouble which generated before can be confirmed by this setting. (Reconfirmation is available even if power supply was turned off once.)</p> <ul style="list-style-type: none"> • If a trouble generates at present, the same contents as those of trouble which is generating at present are displayed. • Only trouble of TO sensor is not displayed by this setting. (Confirm it by setting of trouble which is generating at present.) 	<p>Refer to 2)</p>
<div style="display: flex; flex-wrap: wrap; justify-content: space-around;"> <div style="text-align: center; margin: 5px;"> <p>TD SW803</p>  </div> <div style="text-align: center; margin: 5px;"> <p>TE SW803</p>  </div> <div style="text-align: center; margin: 5px;"> <p>TS SW803</p>  </div> <div style="text-align: center; margin: 5px;"> <p>TO SW803</p>  </div> <div style="text-align: center; margin: 5px;"> <p>TL SW803</p>  </div> <div style="text-align: center; margin: 5px;"> <p>TH SW803</p>  </div> <div style="text-align: center; margin: 5px;"> <p>TA SW803</p>  </div> <div style="text-align: center; margin: 5px;"> <p>TC SW803</p>  </div> <div style="text-align: center; margin: 5px;"> <p>TCJ SW803</p>  </div> </div>	<p>Temperature sensor display The detected value of temperature sensor is displayed.</p>	<p>Refer to 3)</p>
<p style="text-align: center;">SW803</p> 	<p>Current display The current value which flows in the outdoor unit is displayed.</p>	<p>Refer to 3)</p>
<p style="text-align: center;">SW803</p> 	<p>Compressor operation frequency display The operation frequency of the compressor is displayed.</p>	<p>Refer to 3)</p>
<p style="text-align: center;">SW803</p> 	<p>PMV opening display The opening of PMV (Pulse Motor Valve) is displayed.</p>	<p>Refer to 3)</p>
<p style="text-align: center;">SW803</p> 	<p>Ps sensor display Detected Ps sensor is displayed.</p>	<p>Refer to 3)</p>

2) Trouble display

The trouble which is generating at present and the latest trouble (Latest trouble information including present) can be confirmed by lighting LED D800 to D804 on the outdoor control P.C. board.

- When all DIP switch SW803 are OFF, the status of trouble which is generating at present is displayed.
- <1> only of DIP switch SW803 is turned on, the trouble which generated before (Latest trouble information including present) is displayed.)
- If there is a trouble, any of LED D800 to D804 goes on. (Display 1)
- When pushing the pushdown button switch SW800 for approx. 1 second, the display is exchanged. (Display 2)
- When pushing SW800 again or after 2 minutes, the status returns to that of Display ①.

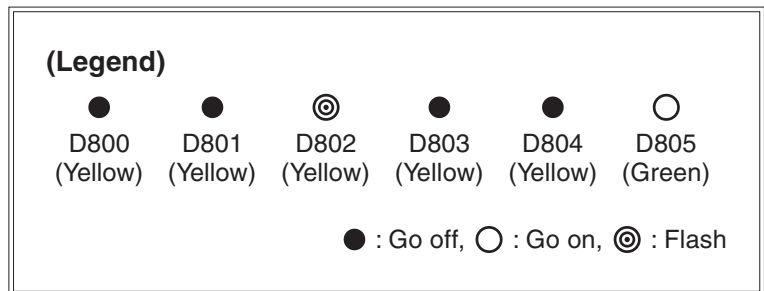
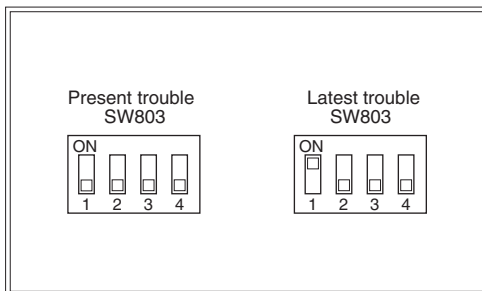

Display 1) (Initial display)	Display 2) (SW800 operation)	Trouble contents	Wired remote controller Check code
●●●●●○	●●●●●○	Normal	—
○○●●○○	●●◎●●○	Discharge temp. sensor (TD) trouble	F04
	●◎◎●●○	Heat exchanger temp. sensor (TE) trouble	F06
	◎◎◎●●○	Heat exchanger temp. sensor (TL) trouble	F06, F07
	●●●◎●○	Outside temp. sensor (TO) trouble	F08
	●●◎◎●○	Suction temp. sensor (TS) trouble	F06, F12
	◎●◎◎●○	Heat sink temp. sensor (TH) trouble	F13, L29
	◎◎◎◎●○	Heat exchanger sensor (TE, TS) miss-wiring	F06, F15
	◎◎◎◎◎○	EEPROM trouble	F31, L29
●●○○○○	◎●●●●○	Compressor break down	H01
	●◎●●●○	Compressor lock	H02
	◎◎●●●○	Current detection circuit trouble	H03
	●●◎●●○	Case thermostat operation	H04, P04
●○○●○○	●◎◎●●○	Model unset	L10, L29
	◎●◎◎◎○	Communication trouble between MCU	L29
	◎◎◎◎◎○	Other trouble (Compressor disorder, etc.)	Trouble is not determined.
○○○●○○	◎◎●●●○	Discharge temp. trouble	P03
	●●◎●●○	High pressure SW system trouble	P04
	◎●◎●●○	Power supply trouble	P04, P05
	◎◎◎●●○	Heat sink overheat trouble	P07, L29
	◎◎◎◎●○	Gas leak detection	P15, L29
	◎◎●●◎○	4-way valve reverse trouble	P19, L29
	●●◎●◎○	High pressure protective operation	P04, P20
	●◎◎●◎○	Fan system trouble	P22
	●◎●◎◎○	Driving element short-circuit	P26
	◎●◎◎◎○	Position detection circuit trouble	P29

* As the Check code displayed on the wired remote controller may differ according to type of indoor model, multiple codes are described.

4) Specific operation for maintenance check (SW801, SW804)

The following specific operations for the maintenance check are performed by operation of SW801 or SW804.

- a) Select DIP switch SW804. (See table below)
- b) Push the pushdown button switch SW801 for approx. 1 second.
- c) The following functions start. While each function starts, LED D805 (Green) flashes.
- d) When pushing the pushdown button switch SW801 again for approx. 1 second, when selecting DIP switch SW804 or when the specified time of each function elapsed, each function stops and LED D805 (Green) returns to the continuous lighting.

<Specific operation>

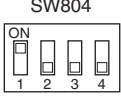
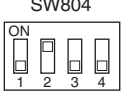
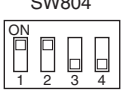
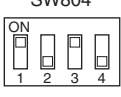
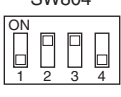
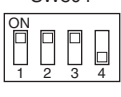
SW804	Operation when pushdown button switch SW801 is pushed	
	Refrigerant recovery operation The outdoor unit performs cooling operation. The indoor unit does not work by this operation alone. Therefore operate the fan beforehand.	
	Indoor cooling test run demand The cooling test run is performed. (→ Note 1)	
	Indoor heating test run demand The heating test run is performed. (→ Note 1)	
	Fan motor forced operation Drive the fan motor forcedly. When pushing SW801 again or when 2 minutes elapsed, the operation returns to the normal control.	[NOTE] Although these operations can be performed even during operation, basically perform operation while the unit stops. If performing this operation during driving the unit, it is dangerous because the pressure may change suddenly.
	PMV full open operation Open PMV (Pulse Motor Valve) fully. When pushing SW801 again or when 2 minutes elapsed, the operation returns to the normal control.	
	PMV full close operation Close PMV (Pulse Motor Valve) fully. When pushing SW801 again or when 2 minutes elapsed, the operation returns to the normal control.	
	PMV middle opening operation Set PMV (Pulse Motor Valve) to middle opening. When pushing SW801 again or when 2 minutes elapsed, the operation returns to the normal control.	

Note 1) Indoor cooling test run demand / Indoor heating test run demand
 Only when combining with the following indoor unit, cooling/heating operation can be performed from the outdoor unit.
 Test run is unavailable: Indoor units other than the above-mentioned indoor units, are included in the twin, triple connection.

Note 2) The forced test run by this setting cannot be cleared on the indoor remote controller.
 Be sure to clear the test run by operation of the outdoor unit. (Push SW801 again for 1 second.)

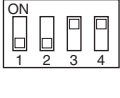
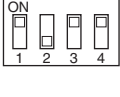
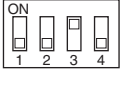
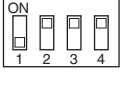
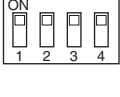
SW804	Operation when pushdown button switch SW801 is pushed	
	<p>4-way valve relay operation (For RY700, CN70 check) Turn on 4-way valve power relay (RY700). When pushing SW801 again or when 2 minutes elapsed, the operation returns to the normal control.</p>	<p>[CAUTION] Although these operations can be performed even during operation, basically perform operation while the unit stops. If performing this operation during driving the unit, it is dangerous because the pressure may change suddenly.</p>
	<p>Heater output relay operation (For check RY703, CN703 check) Turn on relay for option heater (RY703). When pushing SW801 again or when 2 minutes elapsed, the operation returns to the normal control.</p>	
	<p>Outside output relay operation (RY704, CN704) Turn on relay for outside output (RY704). When pushing SW801 again or when 2 minutes elapsed, the operation returns to the normal control.</p>	
	<p>Forced start command The indoor unit connected to the system is forcedly started. (The indoor unit starts operation by setting of the operation mode on the remote controller.)</p>	
	<p>Forced stop command The indoor unit connected to the system is forcedly stopped.</p>	
	<p>Relay operation change for outside output [CAUTION] Do not use this setting.</p>	

9-3-4. Outdoor application operation

Optional connector kit (TCB-KBOS4E)

(1) Peak-cut control

- Saves the power of the outdoor unit by the external peak-cut signal to suppress temporary peak power dissipation.
- The power saving can be switched to three levels: 75%, 50%, and operation stop.

(2) Night operation

- Reduces the capacity of the air conditioner by the input signal from a commercially available timer (procured locally) regardless of the outside air temperature or load to reduce operating noise.

(3) Compressor output

- Turns on the no-voltage contact output while the compressor is operating.

10. ADDRESS SETUP

10-1. Address Setup Procedure

When an outdoor unit and an indoor unit are connected, or when an outdoor unit is connected to each indoor unit respectively in the group operation even if multiple refrigerant lines are provided, the automatic address setup completes with power-ON of the outdoor unit. The operation of the remote controller is not accepted while automatic address works. (Approx. 4 to 5 minutes)

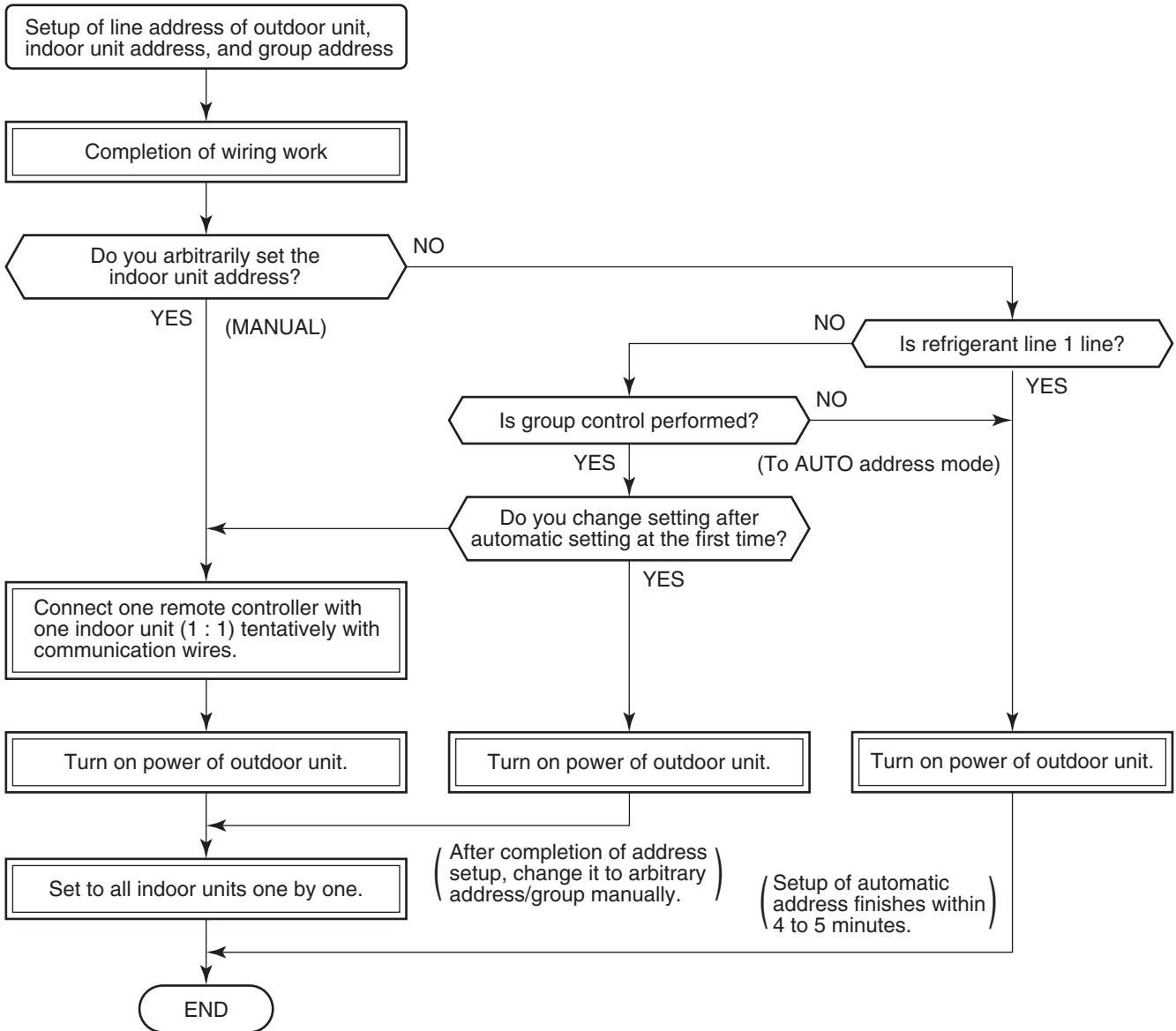

- When the following addresses are not stored in the neutral memory (IC503) on the indoor P.C. board, a test run operation cannot be performed. (Unfixed data at shipment from factory)

	Item code	Data at shipment	Setup data range
Line address	12	0099	0001 (No. 1 unit) to 0064 (No. 64 unit)
Indoor unit address	13	0099	0001 (No. 1 unit) to 0064 (No. 64 unit) Max. value of indoor units in the identical refrigerant line
Group address	14	0099	0000 : Individual (Indoor units which are not controlled in a group) 0001 : Master unit (1 indoor unit in group control) 0002 : Sub unit (Indoor units other than master unit in group control)

10-2. Address Setup & Group Control

<Definitions of terms>

Indoor unit No. : $N - n =$ Outdoor unit line address N (Max. 30) - Indoor unit address n (Max. 64)

Group address : 0 = Single (Not group control)
1 = Master unit in group control
2 = Sub unit in group control

Master unit (= 1) : The representative of multiple indoor units in group operation sends/receives signals to/from the remote controllers and sub indoor units.
(* It has no relation with an indoor unit which communicates serially with the outdoor units.)
The operation mode and setup temperature range are displayed on the remote controller LCD.
(Except air direction adjustment of louver)

Sub unit (= 2) : Indoor units other than master unit in group operation
Basically, sub units do not send/receive signals to/from the remote controllers.
(Except alarm and response to demand of service data)

Header unit (Representative unit) (Master Twin)

: This unit communicates with the indoor unit (follower) which serial-communicates with the outdoor units and sends/receives signal (Command from compressor) to/from the outdoor units as the representative of the cycle control in the indoor units of the identical line address within the minimum unit which configures one of the refrigerating cycles of Twin.

Follower unit (Subordinate unit) (Sub Twin)

: Indoor units excluding the header unit in Twin
This unit communicates with (Header) indoor unit in the identical line address and performs control synchronized with (Header) indoor unit.
This unit does not perform the signal send/receive operation with the outdoor units. :
No judgment for serial signal trouble.

10-2-1. System Configuration

1. Single

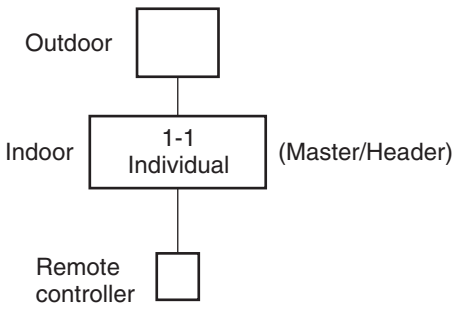

2. Twin

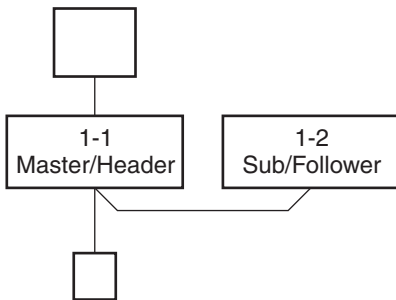

3. Triple

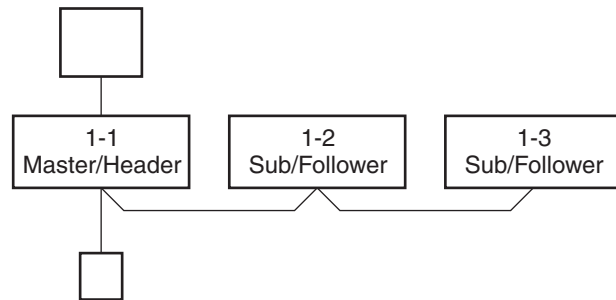

4. Single group operation

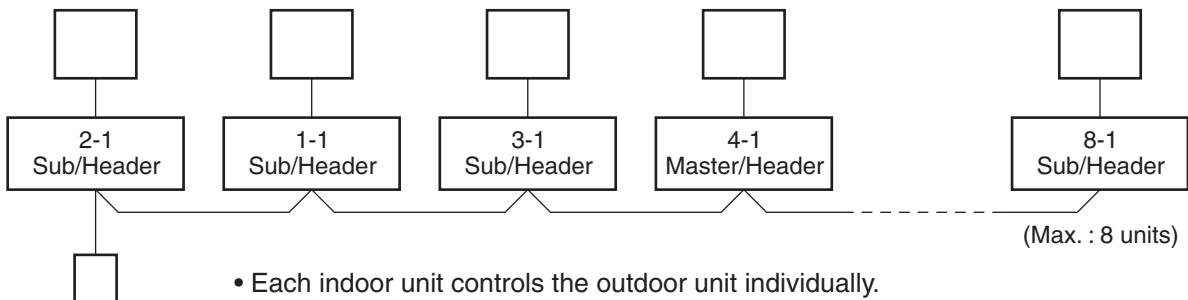

5. Multiple groups operation (Single, Twin, Triple operation) (Manually addresses change)

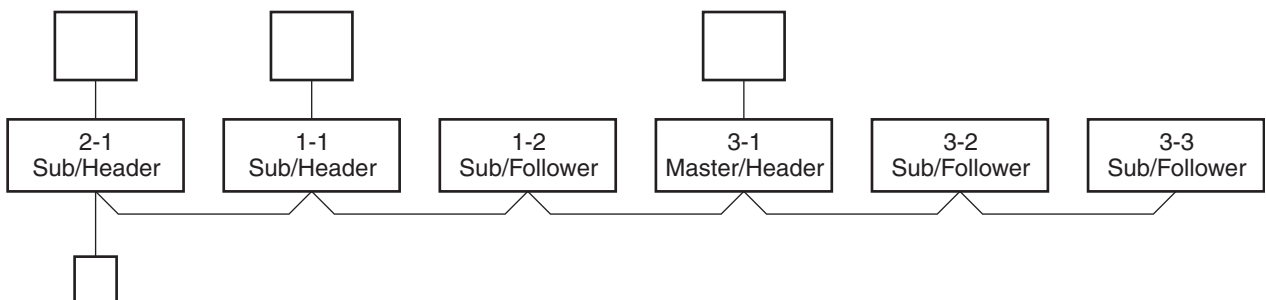

- Header unit: The header unit receives the indoor unit data (thermostat status) of the follower (Without identical line address & indoor/outdoor serial) and then finally controls the outdoor compressor matching with its own thermostat status.
The header unit sends this command information to the follower unit.
- Follower unit: The follower unit receives the indoor unit data from the header (With identical line address & indoor/outdoor serial) and then performs the thermostat operation synchronized with the header unit.
The follower unit sends own thermostat ON/OFF demand to the header unit.
(Example)
No. 3-1 header unit sends/receives signal to/from No. 3-2 and No. 3-3 follower units.
(It is not influenced by the refrigerating line 1 or 2 address indoor unit.)

10-2-2. Automatic Address Example from Unset Address (No miss-wiring)

1. Standard (One outdoor unit)

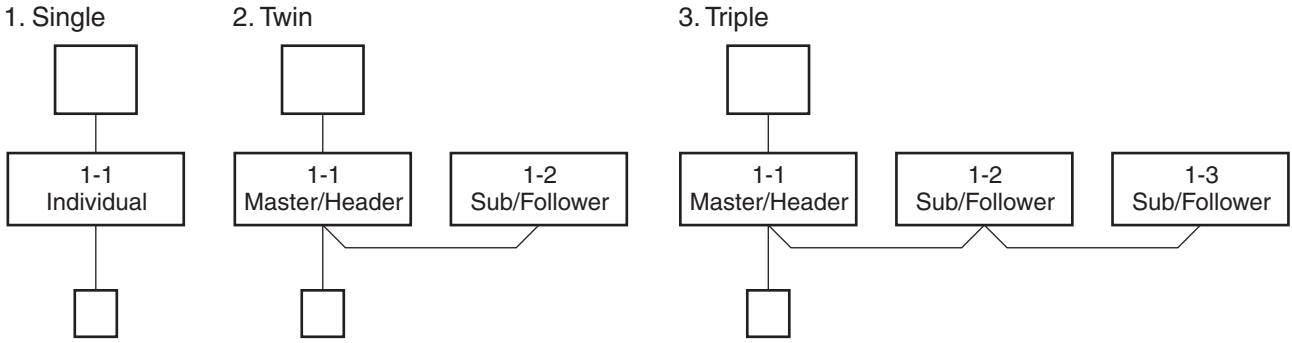

Only turning on source power supply (Automatic completion)

2. Single group operation (Multiple outdoor units = Multiple indoor units only with serial communication)

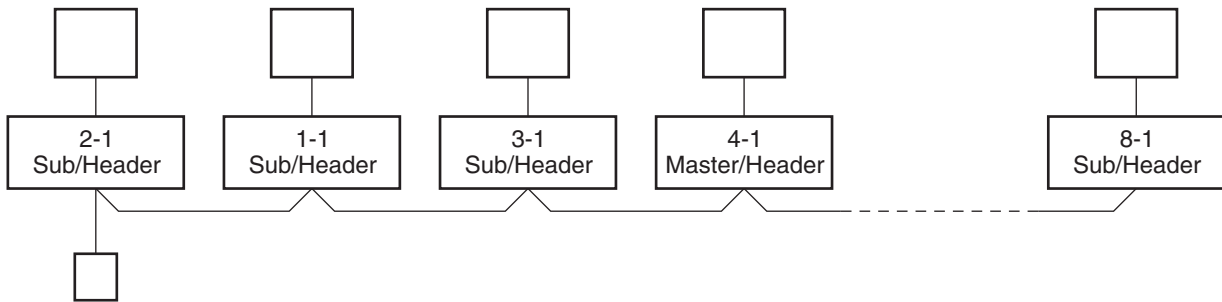

Only turning on source power supply (Automatic completion)

3. Multiple groups operation (Single, Triple, twin operation)

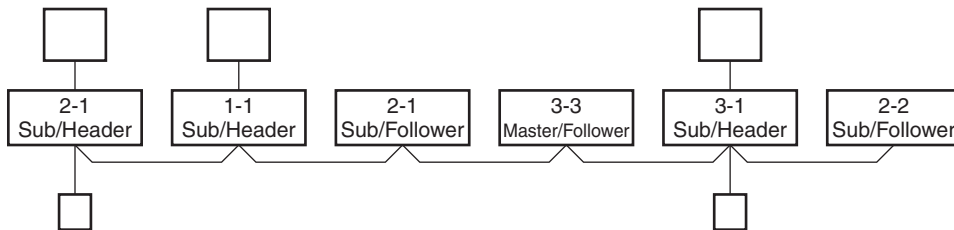

**Change is necessary
Manually change addresses of the multiple follower units
simultaneously from the remote controller.**

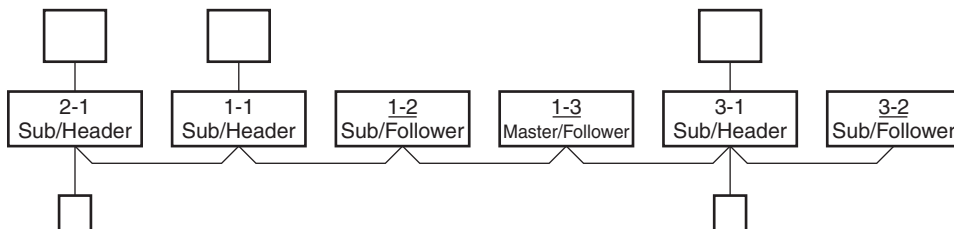

10-3. Remote Controller Wiring

- Strip off approx. 9 mm the wire to be connected.
- For single system, use non polarity, 2 core wire is used for wiring of the remote controller. (0.5 mm² to 2.0 mm² wires)
- For the synchronous twin, triple system, use 2-core shield wire (Vinyl cord for microphone 0.5 to 2.0 mm²) to conform to the EMC standard.

Wiring diagram

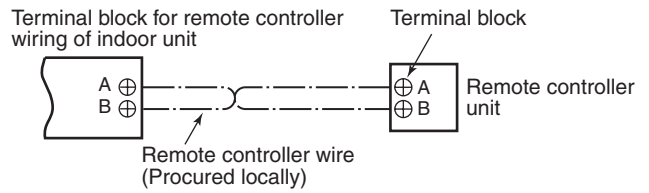

* For details of wiring/installation of the remote controller, refer to the Installation Manual enclosed with the remote controller.

Single system

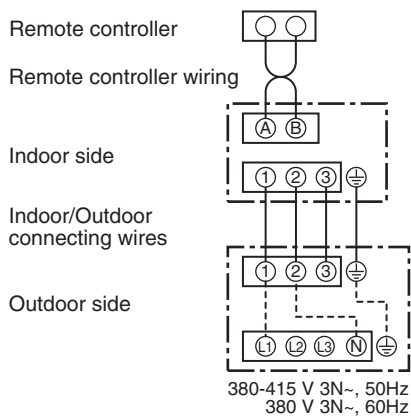

Simultaneous twin system

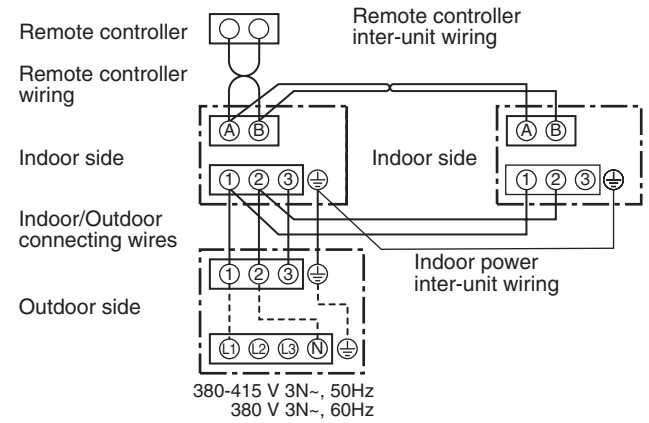

Simultaneous triple system (GP160 only)

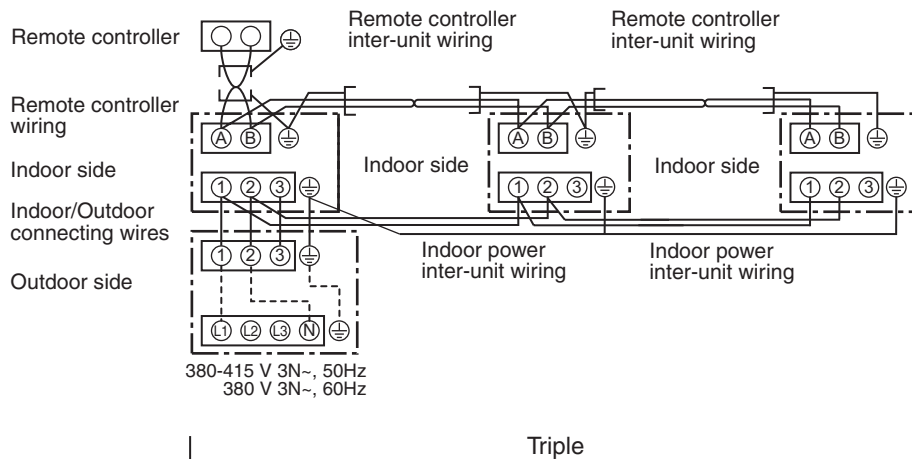

10-4. Address Setup (Manual setting from remote controller)

In case that addresses of the indoor units will be determined prior to piping work after wiring work

- Set an indoor unit per a remote controller.
- Turn on power supply.

(Example of 2-lines cabling)
(Real line: Cabling, Broken line: Refrigerant pipe)

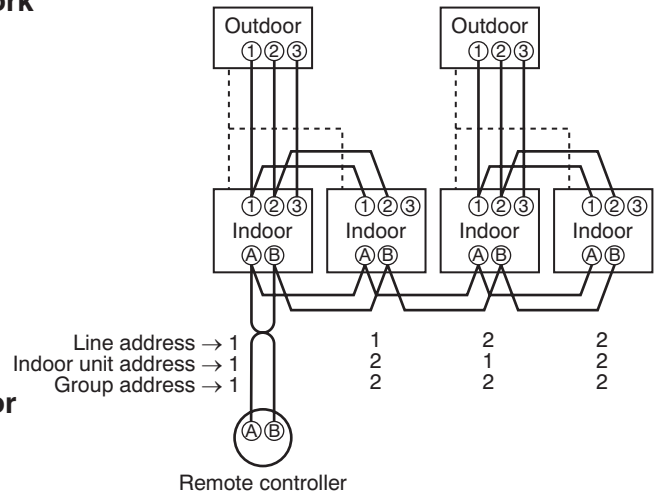

For the above example, perform setting by connecting singly the wired remote controller without remote controller inter-unit cable.

Group address
Individual : 0000
Master unit : 0001
Sub unit : 0002 } In case of group control

- 1 Push **SET** + **CL** + **TEST** buttons simultaneously for 4 seconds or more.
- 2 (← Line address)
Using the temperature setup **▼** / **▲** buttons, set the CODE No. to **12**.
- 3 Using timer time **▼** / **▲** buttons, set the line address.
- 4 Push **SET** button. (OK when display goes on.)
- 5 (← Indoor unit address)
Using the temperature setup **▼** / **▲** buttons, set the CODE No. to **13**.
- 6 Using timer time **▼** / **▲** buttons, set the line address to 1.
- 7 Push **SET** button. (OK when display goes on.)
- 8 (← Group address)
Using the temperature setup **▼** / **▲** buttons, set the CODE No. to **14**.
- 9 Using timer time **▼** / **▲** buttons, set Individual to **0000**, Header unit to **0001**, and Follower unit to **0002**.
- 10 Push **SET** button. (OK when display goes on.)
- 11 Push **TEST** button.
Setup completes. (The status returns to the usual stop status.)

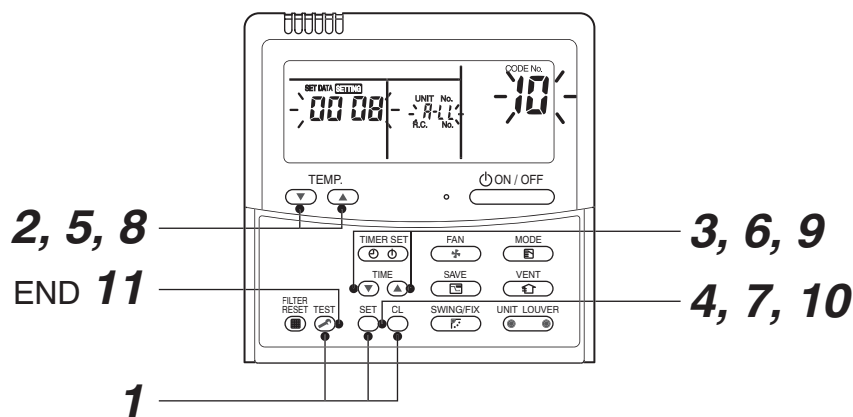

<Operation procedure>



1 → 2 → 3 → 4 → 5 → 6 → 7 → 8 → 9 → 10 → 11 END

10-5. Confirmation of Indoor Unit No. Position

1. To know the indoor unit addresses though position of the indoor unit body is recognized

- In case of individual operation (Wired remote controller : indoor unit = 1 : 1)
(Follow to the procedure during operation)

<Procedure>

- 1 Push  button if the unit stops.
- 2 Push  button (button of left side).

Unit No. 1-1 is displayed on LCD.
(It disappears after several seconds.)
The displayed unit No. indicate line address and indoor unit address.
(When other indoor units are connected to the identical remote controller (Group control unit), other unit numbers are also displayed every pushing  button (button of left side).

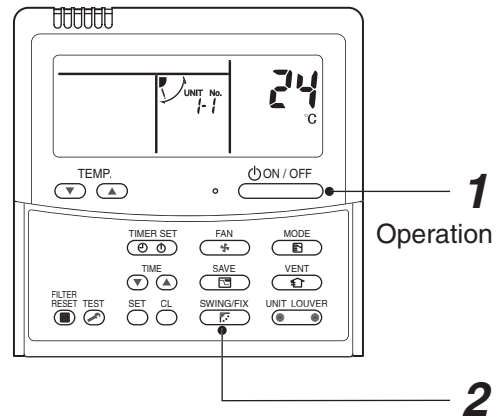

<Operation procedure>

1 → 2 END

2. To know the position of indoor unit body by address

- To confirm the unit No. in the group control
(Follow to the procedure during operation) (in this procedure, the indoor units in group control stop.)

<Procedure>

The indoor unit numbers in the group control are successively displayed, and fan, louver, and drain pump of the corresponding indoor unit are turned on.
(Follow to the procedure during operation)

- 1 Push  and  buttons simultaneously for 4 seconds or more.

- Unit No. ALL is displayed.
- Fans and louvers of all the indoor units in the group control operate.

- 2 Every pushing  button (button of left side), the unit numbers in the group control are successively displayed.

- The unit No. displayed at the first time indicates the master unit address.
- Fan and louver of the selected indoor unit only operate.

- 3 Push  button to finish the procedure.
All the indoor units in the group control stop.

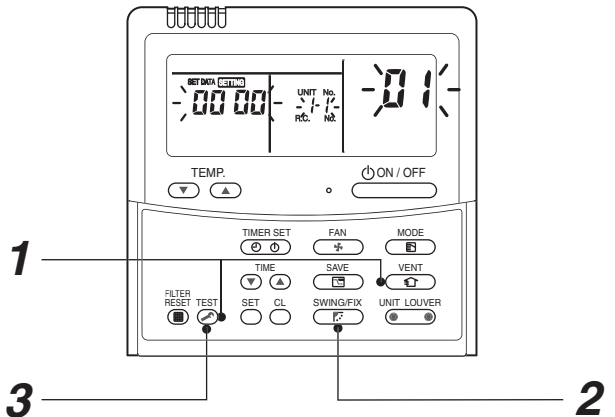

<Operation procedure>

1 → 2 → 3 END

<Maintenance/Check list>

Aiming in environmental preservation, it is strictly recommended to clean and maintain the indoor/outdoor units of the operating air conditioning system regularly to secure effective operation of the air conditioner.

It is also recommended to maintain the units once a year regularly when operating the air conditioner for a long time.

Check periodically signs of rust or scratches, etc. on coating of the outdoor units.

Repair the trouble position or apply the rust resisting paint if necessary.

If an indoor unit operates for approx. 8 hours or more per day, usually it is necessary to clean the indoor/outdoor units once three months at least.

These cleaning and maintenance should be carried out by a qualified dealer.

Although the customer has to pay the charge for the maintenance, the life of the unit can be prolonged.

Failure to clean the indoor/outdoor units regularly will cause shortage of capacity, freezing, water leakage or trouble on the compressor.

Part name	Object		Contents of check	Contents of maintenance
	Indoor	Outdoor		
Heat exchanger	○	○	• Blocking with dust, damage check	• Clean it when blocking is found.
Fan motor	○	○	• Audibility for sound	• When abnormal sound is heard
Filter	○	—	• Visual check for dirt and breakage	• Clean with water if dirty • Replace if any breakage
Fan	○	○	• Visual check for swing and balance • Check adhesion of dust and external appearance.	• Replace fan when swinging or balance is remarkably poor. • If a large dust adheres, clean it with brush or water.
Suction/ Discharge grille	○	—	• Visual check for dirt and scratch	• Repair or replace it if deformation or damage is found.
Drain pan	○	—	• Check blocking by dust and dirt of drain water.	• Clean drain pan, Inclination check
Front panel, Louver	○	—	• Check dirt and scratch.	• Cleaning/Coating with repair painting
External appearance	—	○	• Check rust and peeling of insulator • Check peeling and floating of coating film	• Coating with repair painting

11. REPLACEMENT OF THE SERVICE P.C. BOARD MCC-1599

1. Setting the jumper wires and DIP switches

Part name		Function	Setting
Jumper wire	J800 to J803	Model switching	Cut these jumper wires according to the following table.
	J804 to J811	Settings	Set these jumper wires to the settings of the P.C. board before replacement
DIP switch	SW802	Settings	Set SW802 to the setting of the P.C. board before replacement
	SW803	LED indication switching	Set SW803 to all OFF.
	SW804	Special operations for service	Set SW804 to all OFF
	SW805	Special operations for service	Set SW805 to all OFF

Model switching (J800 to J803)

Since this service P.C. board is available for several models, cut the jumper wires according to the following table. If they are not cut correctly, a check code "L10" or "L29" appears on the wired remote controller and the operation of the air conditioner is disabled.

Model name	J 800	J 801	J 802	J 803
Factory setting (default)	○	○	○	○
RAV-GP1101AT8*	×	○	×	×
RAV-GP1401AT8*	○	×	×	×
RAV-GP1601AT8*	×	×	×	×
[: Characters that indicate the following No. character : Standard models J : For heavily salt-affected areas	○ : Connected, × : Cut			

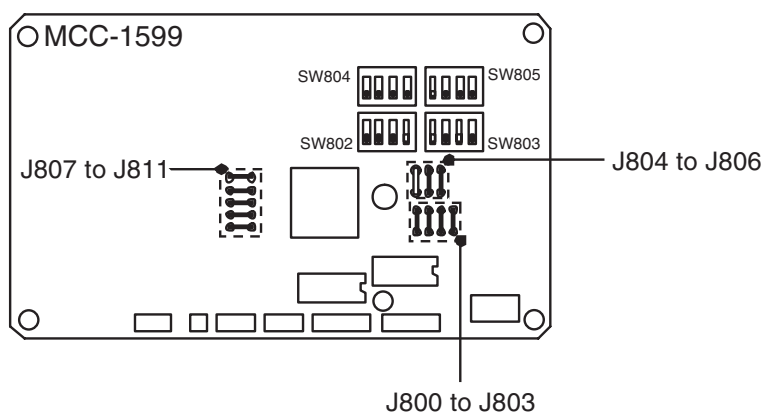

12. HOW TO EXCHANGE COMPRESSOR

12-1. Exchanging Procedure of Compressor (Outline)

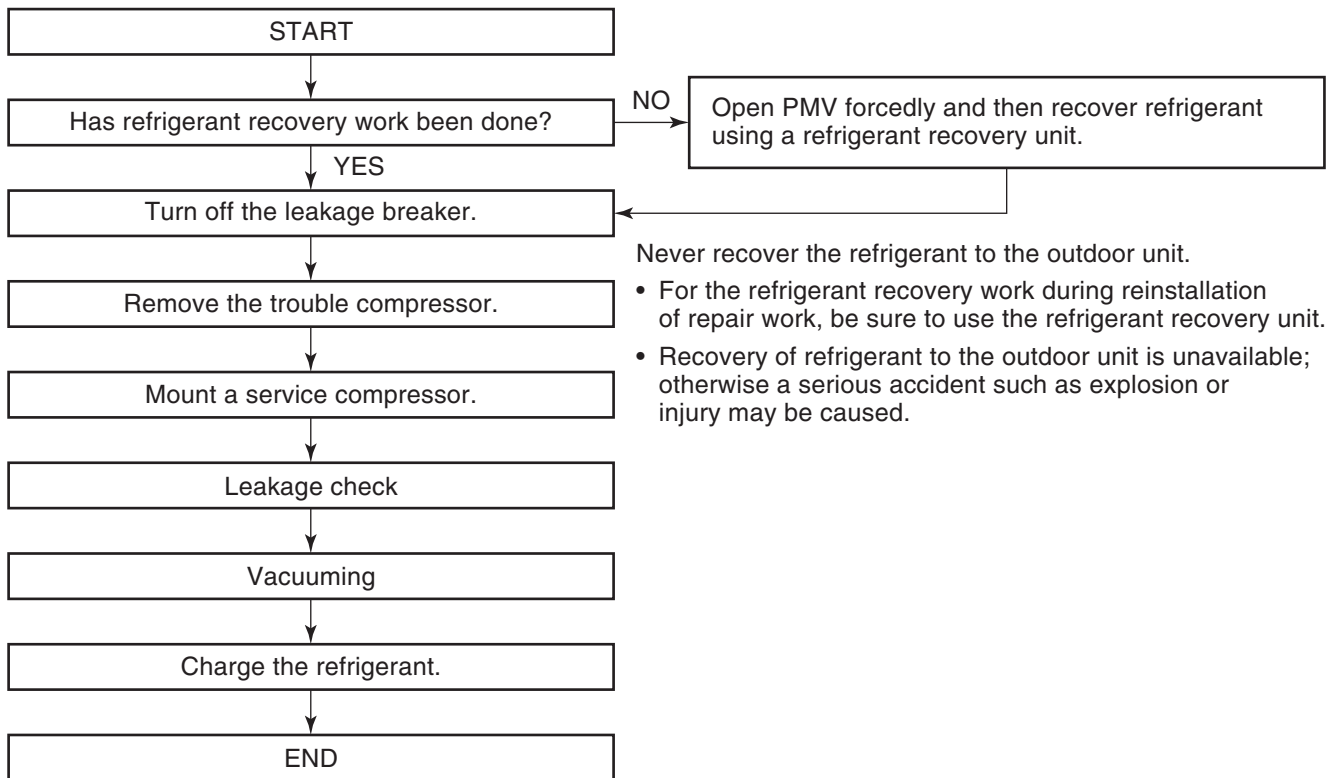

12-2. Exchange of Compressor

For exchange of compressors, refer to (10) Compressor in Section 13. **Attachments.**



13. DETACHMENTS

13-1. Outdoor Unit

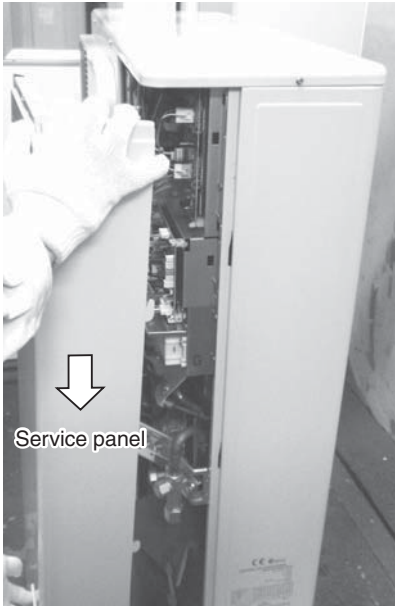
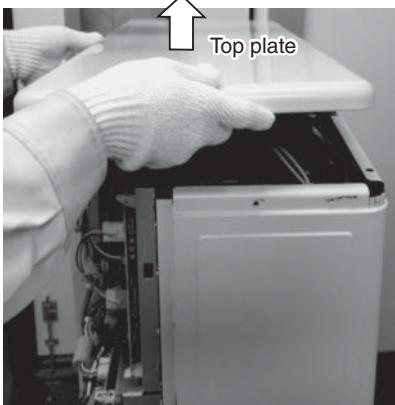
RAV-GP1101AT8*, RAV-GP1401AT8*, RAV-GP1601AT8* series

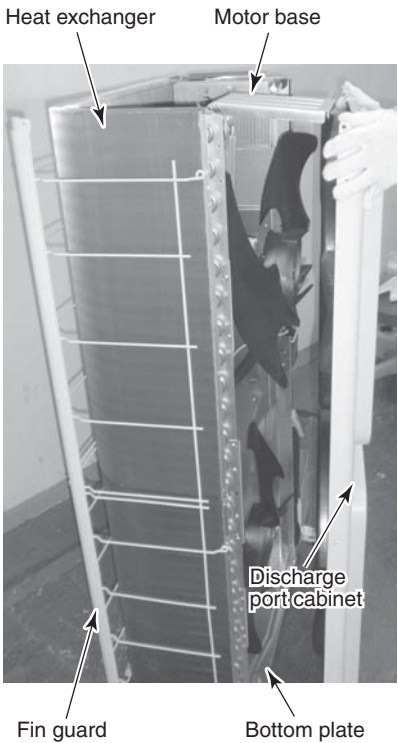
No.	Part name	Procedure	Remarks
①	Common procedure	<hr/> <p style="text-align: center;">⚠ WARNING</p> <p>Stop operation of the air conditioner and turn off breaker switch.</p> <hr/> <p style="text-align: center;">⚠ CAUTION</p> <p>Ensure wearing of gloves when performing any work in order to avoid injury from parts, etc.</p> <hr/> <p>1. Detachment</p> <ol style="list-style-type: none"> 1) Remove the service panel. (Hexagonal screws Ø4 × 10, 2 pcs.) <ul style="list-style-type: none"> • Remove the screws and then pull service panel downward to remove. 2) Remove the power supply cable and the indoor/outdoor connecting wire from the cord clamp and the terminal. 3) Remove the top plate. (Hexagonal screws Ø4 × 10, 5 pcs.) <p>2. Attachment</p> <ol style="list-style-type: none"> 1) Attach the top plate. (Hexagonal screws Ø4 × 10, 5 pcs.) 2) Connect the power supply cable and the indoor/outdoor connecting wire to the terminal and then fix with the cord clamp. <hr/> <p style="text-align: center;">⚠ CAUTION</p> <p>The power supply cable and the indoor/outdoor connecting wire must be affixed along the crossover pipe using a commercially available bundling band so that they do not make contact with the compressor, gas valve, gas pipe and discharge pipe.</p> <hr/> <ol style="list-style-type: none"> 3) Attach the front panel. (Hexagonal screws Ø4 × 10, 2 pcs.) 	 

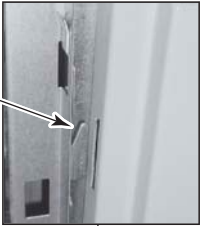
No.	Part name	Procedure	Remarks
②	Discharge port cabinet	<p>1. Detachment</p> <ol style="list-style-type: none"> 1) Carry out the operation in 1. of ① above. 2) Remove the screws fixing the inverter assembly, the discharge port cabinet and the partition board. (ST1T Ø4 × 8, 4 pcs.) 3) Remove the screws for the discharge port cabinet and the bottom plate. (Hexagonal screw Ø4 × 10, 2 pcs.) 4) Remove screw for the discharge port cabinet and heat exchanger. (ST1T Ø4 × 8, 1 pc.) 5) Remove screw for the discharge port cabinet and the motor base. (ST1T Ø4 × 8, 2 pcs.) 6) Remove screws for the discharge port cabinet and the fin guard. (Hexagonal screw Ø4 × 10, 2 pcs.) <p>2. Attachment</p> <ol style="list-style-type: none"> 1) Attach the discharge port cabinet and end board of heat exchanger and fix with a screw. (ST1T Ø4 × 8, 1 pc.) 2) Mount other removed screws into original positions. 	

No.	Part name	Procedure	Remarks
③	Side cabinet	<p>1. Detachment</p> <ol style="list-style-type: none"> 1) Carry out the operation in 1. of ① above. 2) Remove the screws fixing the inverter assembly and the side cabinet. (ST1T Ø4 × 10, 3 pcs.) 3) Remove the screws for the side cabinet and the valve fixing plate. (ST1T Ø4 × 10, 2 pcs.) 4) Remove screw for the side cabinet and piping panel (rear). (Hexagonal screw Ø4 × 10, 2 pcs.) 5) Remove screw for the side cabinet and the bottom plate. (Hexagonal screw Ø4 × 10, 1 pc.) 6) Remove screws for the side cabinet, heat exchanger and the fin guard. (Hexagonal screw Ø4 × 10, 5 pcs.) <p>2. Attachment</p> <ol style="list-style-type: none"> 1) Temporarily suspend the side cabinet on the inverter assembly using the hook. 2) Mount the removed screws in the opposite procedure to that during detachment. 	 <p>Discharge port cabinet Side cabinet Inverter assembly</p> <p>Valve fixing plate</p>  <p>Hook</p> <p>Inverter assembly</p>  <p>Inverter assembly</p> <p>Valve fixing plate</p>

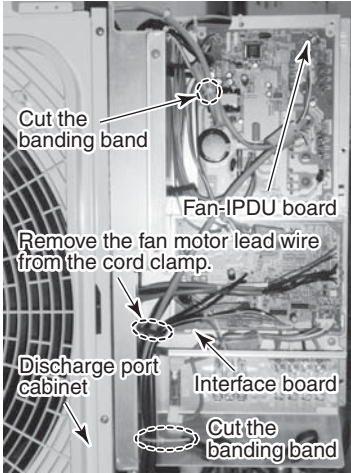
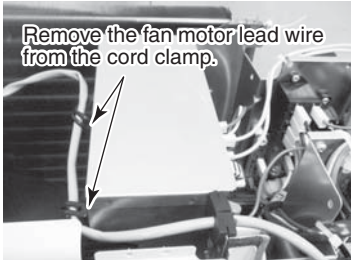
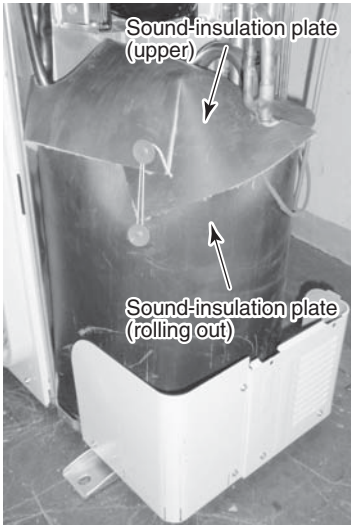
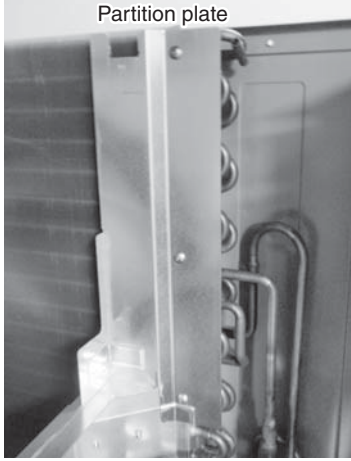
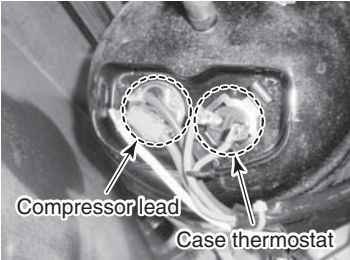
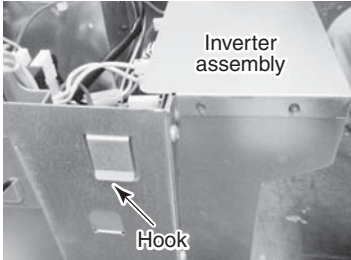
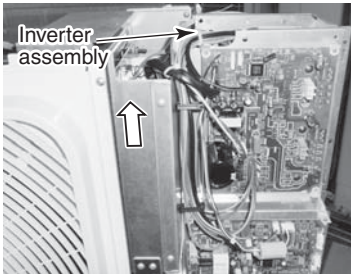
No.	Part name	Procedure	Remarks
④	Inverter assembly	<p>1. Detachment</p> <ol style="list-style-type: none"> 1) Carry out the operation in 1. of ①, 1. of ③ above. 2) Remove the connectors connected to the Fan IPDU board, the connector connected to other components from the control board (Interface board). CN600: TS sensor (3P: White, tube: Gray) CN601: TE sensor (2P: White, tube: Blue) CN602: TO sensor (2P: Yellow, tube: Black) CN603: TD sensor (3P: White, tube: Red) CN604: TL sensor (2P: White, tube: White) CN609: Case thermostat. (2P: Blue) CN690: High pressure switch (3P: Green) CN700: 4-way coil (3P: Yellow) CN710: PMV coil (6P: White) • Fan IPDU board CN700: Outdoors lower fan motor (3P: Blue) CN750: Outdoors upper fan motor (3P: White) Cut the banding band and remove connector connected from fan motor to fan motor relay board. * Remove connectors after unlocking housing section 3) Remove the screw (1 position) fixing the discharge port cabinet. 4) Cut bundling band fixing various lead lines to inverter assembly. 5) Remove sound-insulation plate (upper). 6) Remove terminal cover of compressor and remove compressor lead. 7) Pull up the inverter assembly at upper side to remove hook of partition plate (rear left part). <p>2. Attachment</p> <ol style="list-style-type: none"> 1) Mount the inverter assembly on the partition plate. <hr/> <p style="text-align: center;">⚠ CAUTION</p> <p>When mounting the inverter assembly on the partitioning plate, ensure proper mounting of the hook (rear left part) with partitioning plate.</p> <hr/> <ol style="list-style-type: none"> 2) Mount the individual components in the opposite procedure to that during detachment. 	   
		  	

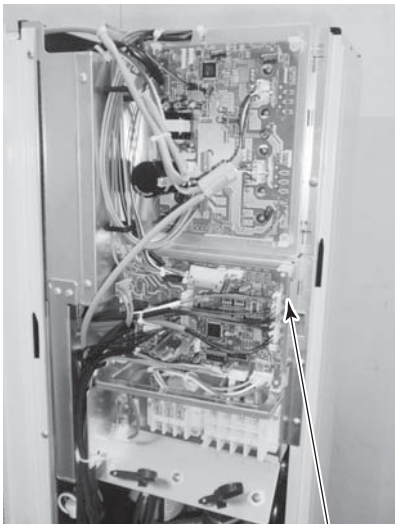
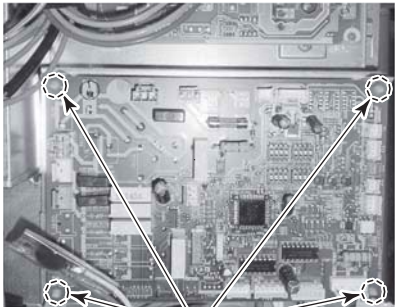
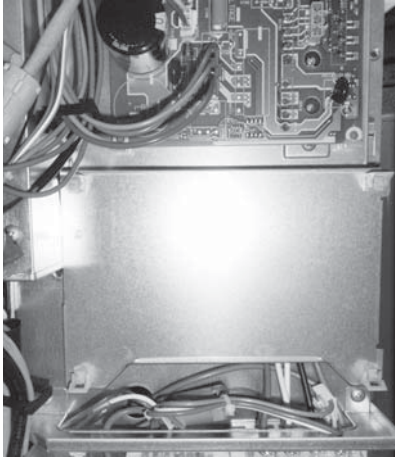
No.	Part name	Procedure	Remarks
⑤	Interface board (Control board) MCC-1599	<p>1. Detachment</p> <p>1) Carry out the operation in 1. of ①, and 1. of ③ above.</p> <p>2) Remove lead wires and connectors to other components from the interface board (control board).</p> <p>CN01 : Indoor/Outdoor connection terminal (5P: White) CN02 : Power relay (3P: Red) CN600 : TS sensor (3P: White, tube: Gray) CN601 : TE sensor (2P: Green, tube: Blue) CN602 : TO sensor (2P: Yellow, tube: Black) CN603 : TD sensor (3P: White, tube: Red) CN604 : TL sensor (2P: White, tube: White) CN608 : Connection with noise filter board (2P: White) CN609: Case thermostat. (2P :Blue) CN690 : High pressure switch (3P: Green) CN700 : 4-way coil (3P: Yellow) CN708 : Magnet switch (3P: Blue) CN710 : PMV coil (6P: White) CN802 : Connection with Fan IPDU board (5P: white)</p> <p>* Remove connectors after unlocking housing section</p> <p>3) Remove the claws of the supports (4 positions) fixing the board and remove the interface board (Control board).</p> <p>2. Attachment</p> <p>1) Mount the interface board (Control board).</p> <p>2) Mount the individual components in the opposite procedure to that during detachment.</p>	 <p>Interface board (Control board)</p>  <p>Support (4 positions)</p>  <p>Statue of control board when removed</p>

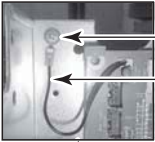
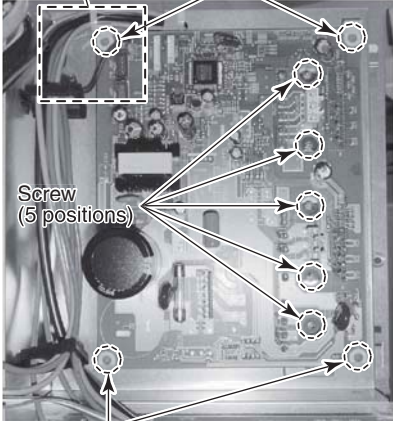
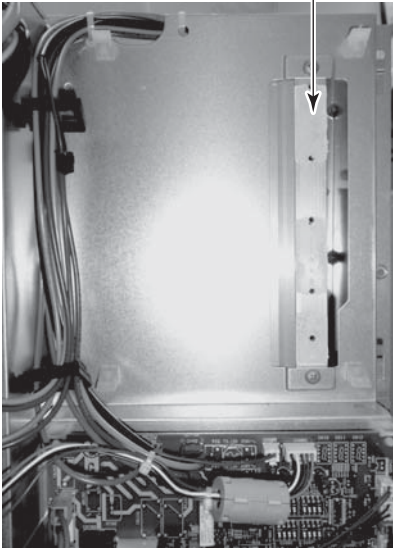
No.	Part name	Procedure	Remarks
⑥	Fan-IPDU board MCC-1597	<p>1. Detachment</p> <ol style="list-style-type: none"> 1) Carry out the operation in 1. of ①, and 1. of ③ above. 2) Remove lead wires and connectors to other components from the Fan-IPDU board. CN500 : Connection between reactor and noise filter board (7P, Red) CN502 : Compressor IPDU board (3P, White) CN504 : Interface board (5P, Blue) CN505 : Compressor IPDU board (5P, Red) CN602 : Noise filter board (2P, Black) CN700 : Outdoors lower fan motor (3P, Blue) CN750 : Outdoors upper fan motor (3P, White) <p>* Connectors should be removed after unlocking the housing section.</p> <ol style="list-style-type: none"> 3) Remove screw fixing the earth wire. 4) Remove the claw of the support (4 positions) fixing the board and the screw (5 positions) fixing the heat sink and then remove the Fan-IPDU board. <p>2. Attachment</p> <ol style="list-style-type: none"> 1) Mount Fan-IPDU board 2) Mount components in the opposite method to that when removing. 	<p>FAN-IPDU board</p>   <p>Screw Earth wire</p> <p>Support (2 positions)</p>  <p>Screw (5 positions)</p> <p>Support (2 positions)</p> <p>Heat sink</p>  <p>State of Fan-IPDU board when removed</p>

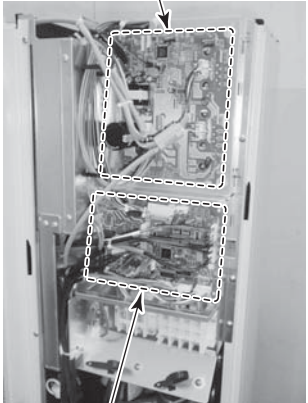
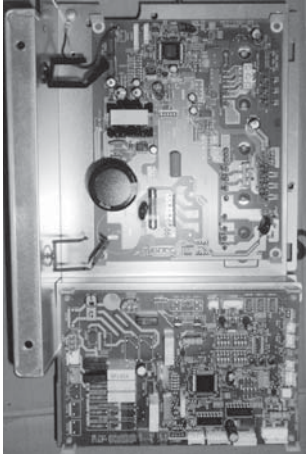
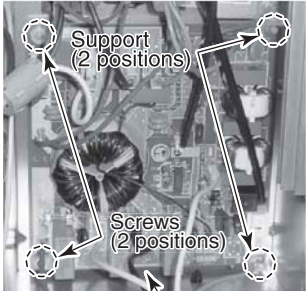
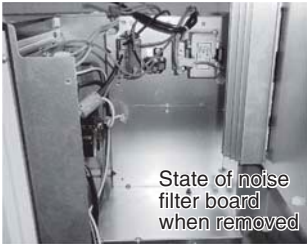
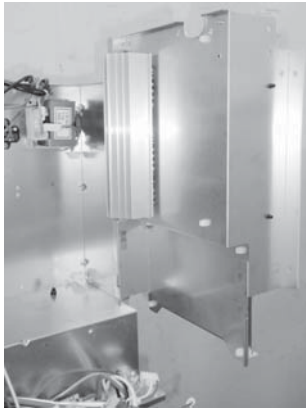
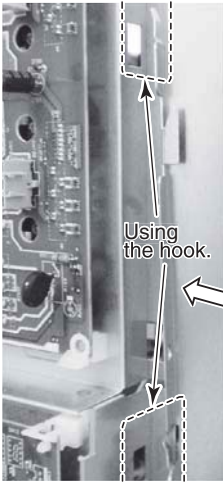
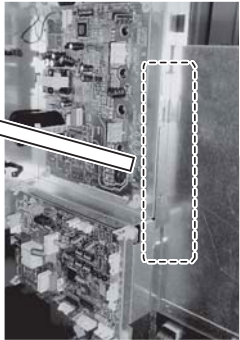
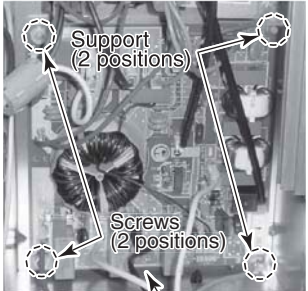
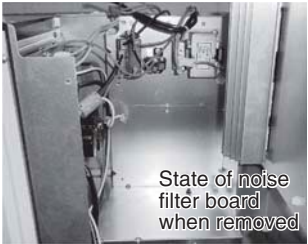
No.	Part name	Procedure	Remarks
⑦	Noise filter board MCC-1600	<p>1. Detachment</p> <ol style="list-style-type: none"> 1) Perform the operation in 1. of ①, 1. of ④, 1.-2 of ⑤ and 1.-2 of ⑥. 2) Remove the screws (3 positions) fixing the inverter assembly (front). Then slide the inverter assembly (front) upwardly and remove. 3) Remove the lead wires connector to other components from the noise filter board. <p>CN05: Power supply terminal block (red) CN06: Power supply terminal block (White) CN07: Power supply terminal block (Black) CN08: Power supply terminal block (Gray) CN09: Connection to earth (Brown) CN10: Posistor (Red) CN16: Relay (Red) CN17: Compressor IPDU board (White) CN18: Relay (Black) CN19: Relay (Gray) CN20: Power supply terminal block (White) CN23: Fan-IPDU board (5P, Red) CN50: Interface board (2P, White) CN51: Fan-IPDU board (2P, Back)</p> <p>* Connectors should be removed after unlocking the housing section.</p> <ol style="list-style-type: none"> 4) Remove the claw of the support (2 positions) and the screw (2 positions) fixing the base and then remove the noise filter base. <p>2. Attachment</p> <ol style="list-style-type: none"> 1) Mount noise filter board. 2) Mount components in the opposite method to that when removing. 	<p>Fan-IPDU board</p>  <p>Interface board</p>  <p>Inverter assembly (front)</p>  <p>Noise filter board</p>  <p>State of noise filter board when removed</p>
 <p>Using the hook, it is possible to temporarily suspend the inverter assembly (front).</p>		 <p>Using the hook.</p> 	 <p>Noise filter board</p>  <p>State of noise filter board when removed</p>

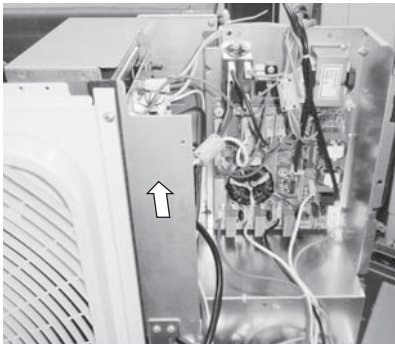
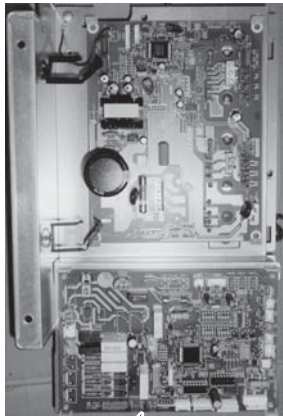
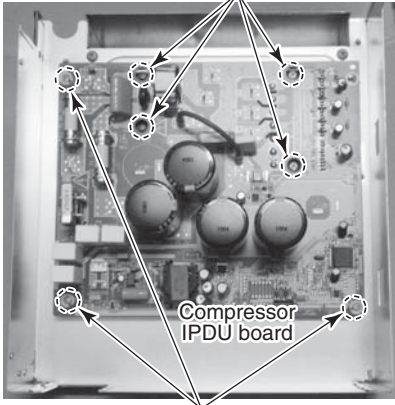
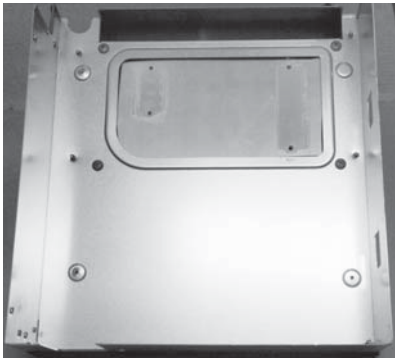
No.	Part name	Procedure	Remarks
⑧	Compressor IPDU board MCC-1596	<p>1. Detachment</p> <ol style="list-style-type: none"> 1) Carry out the operation in 1. of ①, 1. of ④, 1. of ⑤, 1. of ⑥ and 1. of ⑦. 2) Remove the screw (4 positions) fixing the inverter assembly (IPDU). 3) Remove the lead wire and connector to other components from the compressor IPDU board. CN04 : Posistor (Red) CN09 : Power supply terminal block (Yellow) CN10 : Power supply terminal block (Yellow) CN11 : Relay (Red) CN12 : Noise filter board (White) CN13 : Relay (Black) CN101 : FAN-IPDU board (3P, White) CN211 : Compressor (Red) CN212 : Compressor (White) CN213 : Compressor (Black) CN851 : FAN-IPDU board (5P, Red) <p>* Connectors should be removed after unlocking the housing section.</p> <ol style="list-style-type: none"> 4) Slide and remove the inverter assembly (IPDU). 5) Remove the screws (4 positions) fixing the heat sink and the screws (3 positions) fixing the compressor IPDU board and then remove the compressor IPDU board. <p>2. Attachment</p> <ol style="list-style-type: none"> 1) Mount compressor IPDU board. 2) Mount components in the opposite method to that when removing. 	  <p>Inverter assembly (front)</p> <p>Screws (4 positions)</p>  <p>Compressor IPDU board</p> <p>Screws (3 positions)</p>  <p>State of compressor IPDU board when removed</p>

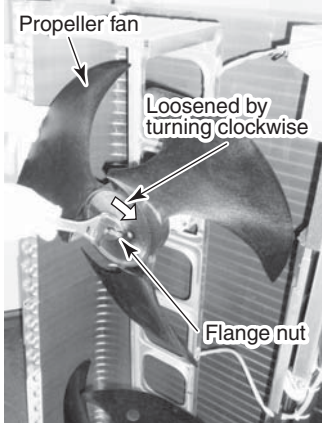
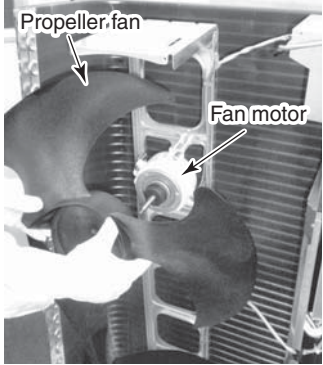
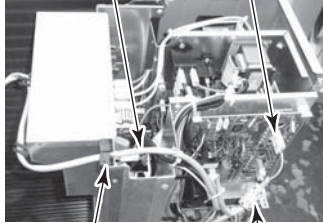
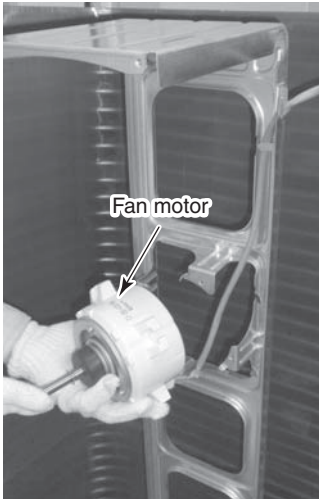
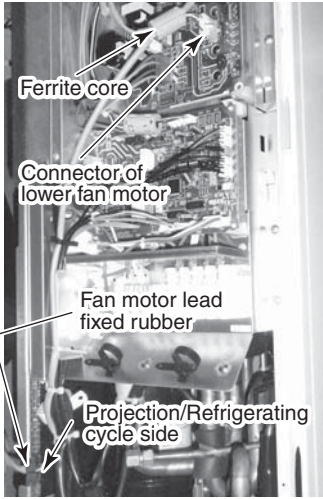
No	Part name	Procedure	Part name
⑨	Fan motor	<p>1) Carry out works of item 1 of ① and work of ②.</p> <p>2) Remove the flange nut fixing the fan motor and the propeller fan.</p> <ul style="list-style-type: none"> The flange nut is loosened by turning it clockwise. (When tightening it, turn it counterclockwise.) <p>3) Remove the propeller fan.</p> <p>4) Remove the connector for the fan motor from the inverter. (Remove the ferrite core of the lower fan motor because it is used.)</p> <p>5) Remove the fan motor lead from the fan motor lead fixed rubber of the penetrated part of the partition board.</p> <p>6) Remove the fixing screws (4 pieces each) while supporting the fan motor so that it does not fall down.</p> <p>* Cautions for assembling of fan motor</p> <ul style="list-style-type: none"> Tighten the flange nut with 4.95N•m (50kgf•cm). Adjust length of the fan motor lead wire at the fan motor lead fixed rubber so that the fan motor lead is not slackened; otherwise the fan motor lead may come to contact with the propeller fan. <p>Attach the fan motor lead fixed rubber to the partition board so that the projection is set at the refrigerating cycle side.</p> <ul style="list-style-type: none"> Be sure so that the reactor body does not contact with the fan motor lead. Be sure to bundle the removed bundling band with the bundling band on the market. Necessarily attach the ferrite core of the lower fan motor again. (Fix it with bundling band on the market.) 	 <p>Propeller fan</p> <p>Loosened by turning clockwise</p> <p>Flange nut</p>  <p>Propeller fan</p> <p>Fan motor</p>  <p>Projection/Refrigerating cycle side</p> <p>Fan motor lead fixed rubber</p> <p>Ferrite core</p>  <p>Fan motor</p>  <p>Ferrite core</p> <p>Connector of lower fan motor</p> <p>Fan motor lead fixed rubber</p> <p>Projection/Refrigerating cycle side</p>
		<p>REQUIREMENT</p> <p>Be sure to fix the fan motor lead to the motor base using the metal band of the motor base so that the fan motor lead does not come to contact with the propeller fan.</p>	

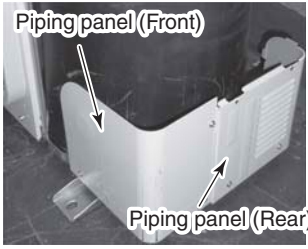
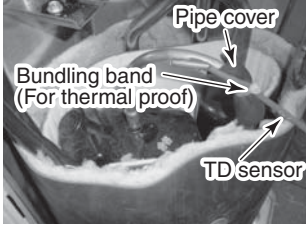
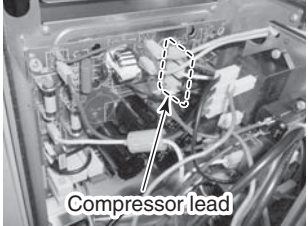
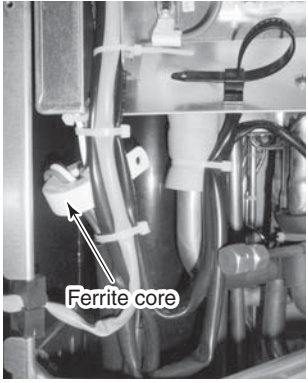
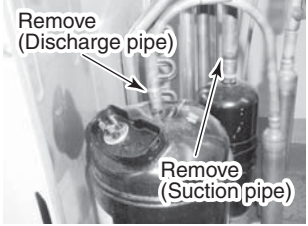
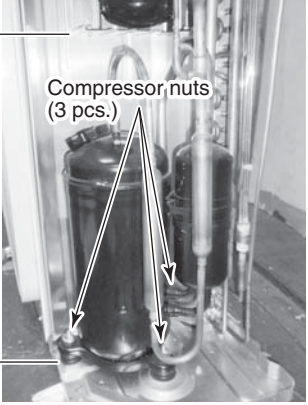
No.	Part name	Procedure	Remarks
⑩	Compressor Compressor lead	<p>1. Removal of trouble compressor</p> <ol style="list-style-type: none"> 1) Recover the refrigerant gas. 2) Carry out work of item 1 of ①, 1 of ③ and 1 of ⑦. 3) Remove the piping panel (Front). Remove the piping panel (Front) and screws of the bottom plate. (Hexagonal screw $\text{Ø}4 \times 10$, 2 pcs.) Remove screw of the piping panel (Front) and the piping panel (Rear). (Hexagonal screw $\text{Ø}4 \times 10$, 1 pc.) 4) Remove the piping panel (Rear). Remove the piping panel (Rear) and screws of the bottom plate. (Hexagonal screw $\text{Ø}4 \times 10$, 2 pcs.) 5) Remove the sound-insulation plate. (Upper, rolling in, rolling out) 6) Remove the terminal cover of the compressor and then remove the compressor lead and the compressor case thermostat. 7) Remove TD sensor which is fixed to the discharge pipe. 8) Remove the compressor lead. Control P.C. board U : CN211 Red V : CN212 White W : CN213 Black 9) Remove ferrite core from compressor lead. 10) Using a burner, remove the discharge pipe and the suction pipe which are connected to the compressor. <hr/> <p style="text-align: center;">⚠ WARNING</p> <p>In case of removing the piping by broiling the welded part with a burner, if there is oil in the pipe, it may burst into flames at the moment that wax melted, so take sufficient care.</p> <hr/> <p style="text-align: center;">CAUTION</p> <p>Note so that the flame does not catch the 4-way valve and PMV. (A malfunction may be caused.)</p> <hr/> <ol style="list-style-type: none"> 11) Pull off the discharge pipe and the suction pipe of the refrigerating cycle upward. 12) Remove the compressor nuts which fix the compressor to the bottom plate. (3 pcs.) 13) Pull out the compressor toward you. <hr/> <p style="text-align: center;">CAUTION</p> <p>As weight of the compressor is 20kg or more, handle it by 2 workers.</p> <hr/>	     

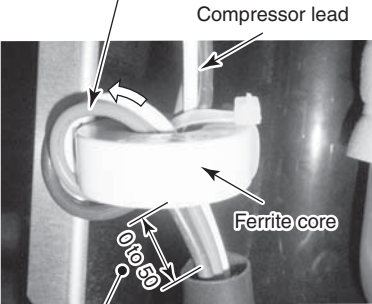
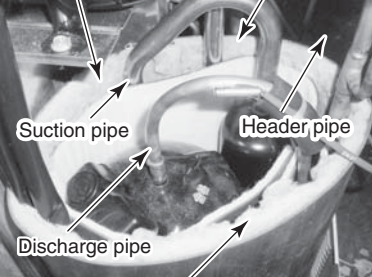
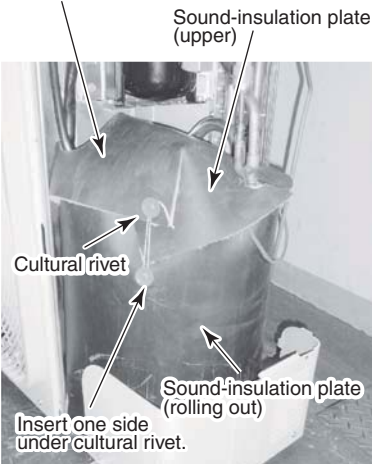
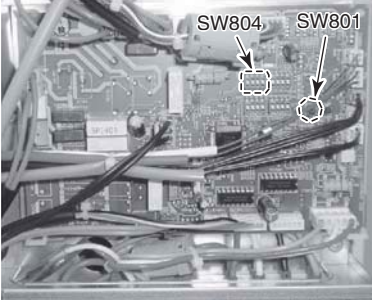
No.	Part name	Procedure	Remarks
⑩	Compressor Compressor lead (Continued)	<p>2. Mounting of compressor</p> <p>1) Mount the compressor in the reverse procedure for removal.</p> <hr/> <p style="text-align: center;">NOTE</p> <ul style="list-style-type: none"> After replacement of the compressor, be sure to replace the compressor lead. (Repair part code of compressor lead: 43160612) In this time, wrap the ferrite core with the compressor lead wire by 1 time. As shown in the right figure, mount the sound-insulation plate (rolling in, rolling out) by passing through it between the compressor and the piping, and between the piping and the partition board. Fix TD sensor by the bundling band for heat-proof on the market via the pipe cover so that TD sensor does not directly come to contact with the discharge pipe. <hr/> <p>3. Vacuuming</p> <p>1) Connect the vacuum pump to the charge port and the check joint of the gas pipe valve and then drive the vacuum pump.</p> <p>2) Carry out vacuuming until the vacuum low pressure gauge indicates 1 (mmHg).</p> <hr/> <p style="text-align: center;">NOTE</p> <p>Before vacuuming, open PMV fully. If PMV is closed, vacuum may be impossible between liquid pipe valve and PMV of the outdoor unit.</p> <hr/> <p>Forced full-opening method of PMV</p> <ul style="list-style-type: none"> Turn on the leakage breaker. Turn on 1 and 3 of Dip switch SW804 on the control P.C. board of the outdoor unit. Keep pushing SW801 on the control P.C. board of the outdoor unit for 1 second or more. After pushing SW801 for 1 second or more, turn off the leakage breaker within 2 minutes. <p>4. Refrigerant charge</p> <p>1) Add the refrigerant amount determined by the pipe length from the charge port of the valve.</p>	<p>Wrap the ferrite core with the compressor lead wire for 1 time.</p>  <p>0 to 50 (Compressor lead positioning standard)</p> <p>Put the end of sound-insulation plate (rolling out) on the other end at this position.</p> <p>Pass through sound-insulation plate (rolling out) between suction pipe and header pipe.</p>  <p>Pass through sound-insulation plate (rolling in) between compressor and discharge pipe, suction pipe and then put the end of sound-insulation plate on the other end at this position.</p> <p>There should be no clearance between sound-insulation plate (upper) and sound-insulation plate (rolling out).</p>  <p>Insert one side under cultural rivet.</p>  <p>SW804 SW801</p>

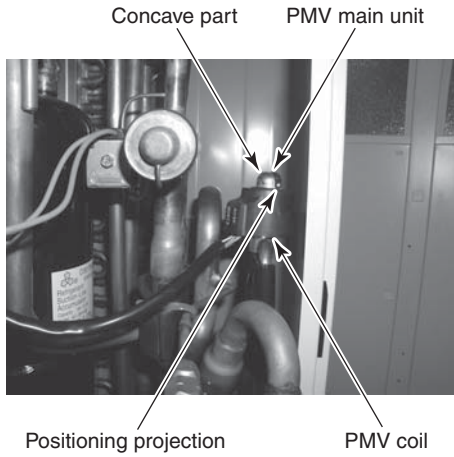
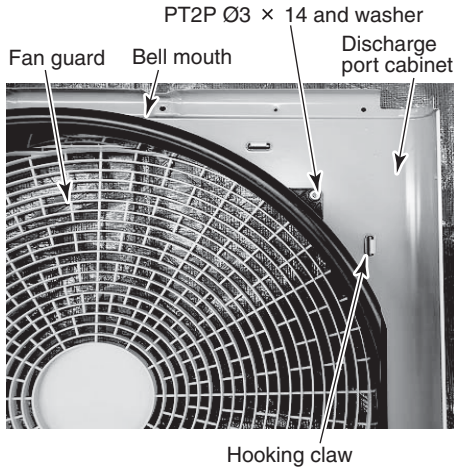
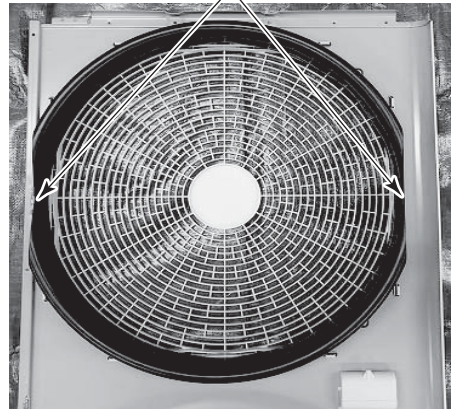
No.	Part name	Procedure	Remarks
⑪	PMV coil	<p>1. Detachment</p> <ol style="list-style-type: none"> 1) Carry out work of item 1 of ①. 2) Turn the coil while pulling upward and then remove the coil from the PMV main unit. <p>2. Attachment</p> <ol style="list-style-type: none"> 1) Surely match the positioning projection of the coil with the concave part of PMV main unit and then fix it. 	
⑫	Fan guard	<p>1. Detachment</p> <ol style="list-style-type: none"> 1) Carry out works of item 1 of ① and 1 of ②. <hr/> <p style="text-align: center;">REQUIREMENT</p> <p>To prevent scratch on the product, carry out the work on cardboard, cloth, etc.</p> <hr/> <ol style="list-style-type: none"> 2) Remove the discharge port cabinet and then put on it so that the fan guard side directs downward. 3) Remove the screw for the bell mouth and fan guard. (PT2P Ø3 × 14 and washer, 4 pcs.) 4) Remove the hooking claws (8 positions) of the fan guard. <p>2. Attachment</p> <ol style="list-style-type: none"> 1) Push the hooking claws (8 positions) with hands from the front side to fix the claws. 2) Attach the bell mouth fixed with screws and washers. (PT2P Ø3 × 14 and washer, 4 pcs.) <hr/> <p style="text-align: center;">REQUIREMENT</p> <p>Check that all the hooking claws are fixed at the specified positions.</p> <hr/>	 

14. EXPLODED VIEWS AND PARTS LIST

14-1. Outdoor Unit

RAV-GP1101AT8-E, RAV-GP1101AT8J-E
RAV-GP1101AT8-TR, RAV-GP1101AT8J-TR

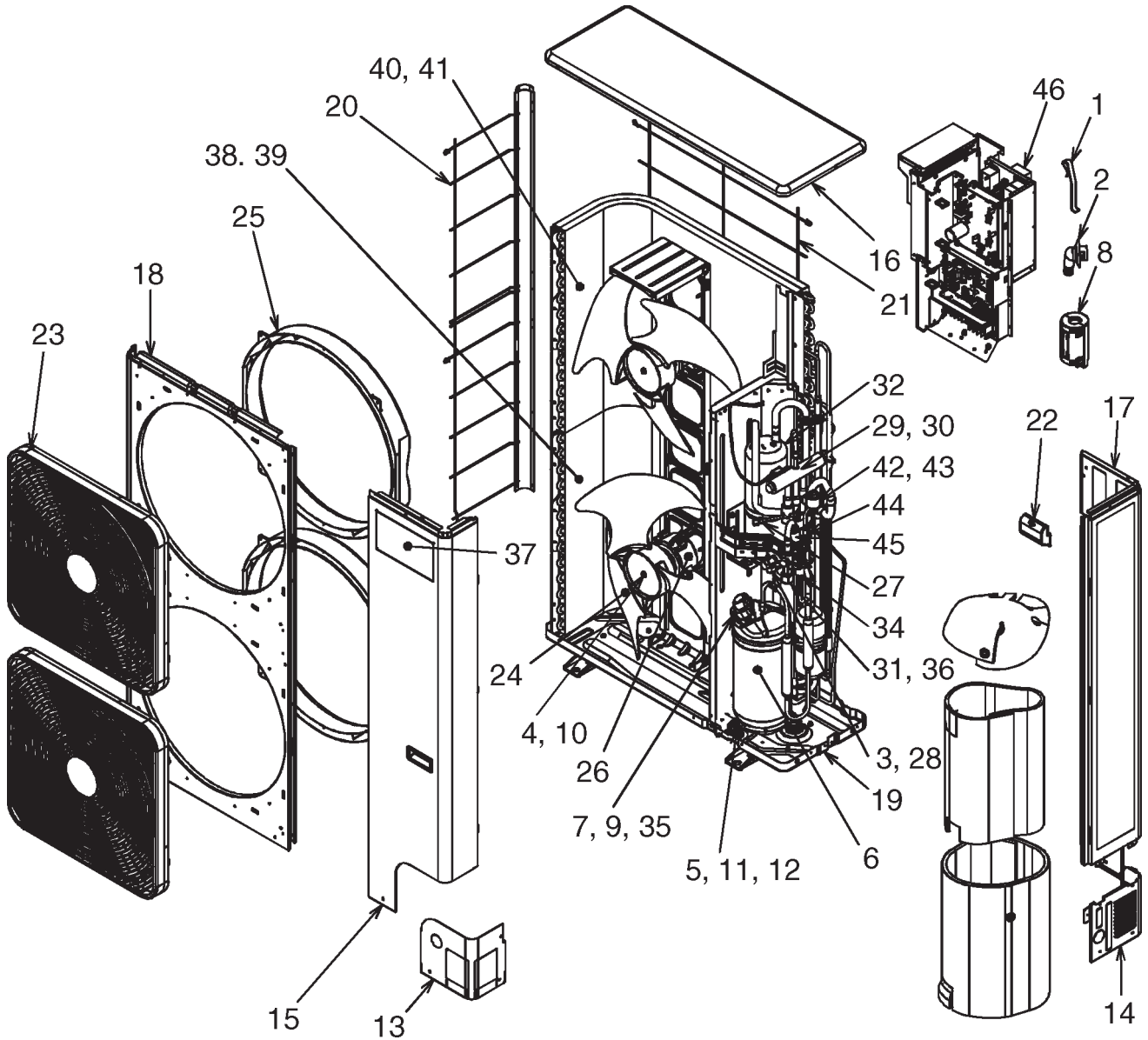

Location No.	Part No.	Description	Model name	RAV-GP
			1101AT8-E 1101AT8-TR	1101AT8J-E 1101AT8J-TR
1	43F19904	HOLDER, SENSOR (TS)	3	3
2	43F32441	NIPPLE, DRAIN	1	1
3	43F47401	BONNET, 3/8 IN	1	1
4	43F47669	NUT, FLANGE	2	
5	43049739	CUSHION, RUBBER	3	3
6	43141530	COMPRESSOR, RX420A3F-27M	1	1
7	43F50407	THERMOSTAT,BIMETAL	1	1
8	43F60029	FILTER, NOISE	1	1
9	43F63317	HOLDER,THERMOSTAT	1	1
10	43197164	NUT, FLANGE		2
11	43197174	NUT, COMP		3
12	43F97212	NUT	3	
13	43100437	PANEL, FRONT, PIPING	1	1
14	43100438	PANEL, BACK, PIPING	1	1
15	43100439	PANEL, FRONT	1	1
16	43100440	PLATE, ROOF	1	1
17	43100470	PANEL, SIDE	1	1
18	43100442	PANEL, AIR OUTLET	1	1
19	43100443	BASE ASSY	1	1
20	43107274	GUARD, FIN, SIDE	1	1
21	43107275	GUARD, FIN, BACK	1	1
22	43107276	HANGER	3	3
23	43119540	GUARD, FAN ASSY	2	2
24	43120244	FAN, PROPELLER, PB521	2	2
25	43122113	BELL MOUTH	2	2
26	4312C100	MOTOR, FAN, ICF-280-A100-1 (A)	2	2
27	43146676	JOINT,CHECK	1	1
28	4314N092	VALVE, PACKED, 9.52	1	1
29	37546878	VALVE, 4-WAY, STF-H0404	1	1
30	4314N080	COIL, SOLENOID, STF-H01AJ1736A1	1	1
31	43146724	VALVE, BALL, SBV-JA5GTC-1, ROHS	1	1
32	43148294	ACCUMULATOR	1	1
34	43151301	SWITCH, PRESSURE	1	1
35	43160612	LEAD ASSY, COMPRESSOR	1	1
36	43147194	BONNET, 5/8 IN	1	1
37	4311M659	MARK, TOSHIBA	1	1
38	4314G266	CONDENSER ASSY, DOWN	1	
39	4314G268	CONDENSER ASSY, DOWN		1
40	4314G269	CONDENSER ASSY, UP	1	
41	4314G271	CONDENSER ASSY, UP		1
42	4314N023	VALVE, PLUS, MODULAING, UKV-25D100	1	1
43	4314N025	COIL, PMV, UKV-A038	1	1
44	4314Q031	STRAINER	1	1
45	4314Q032	STRAINER	1	1
46	43158227	REACTOR	1	1

Outdoor Unit

RAV-GP1401AT8-E, RAV-GP1401AT8J-E
RAV-GP1401AT8-TR, RAV-GP1401AT8J-TR

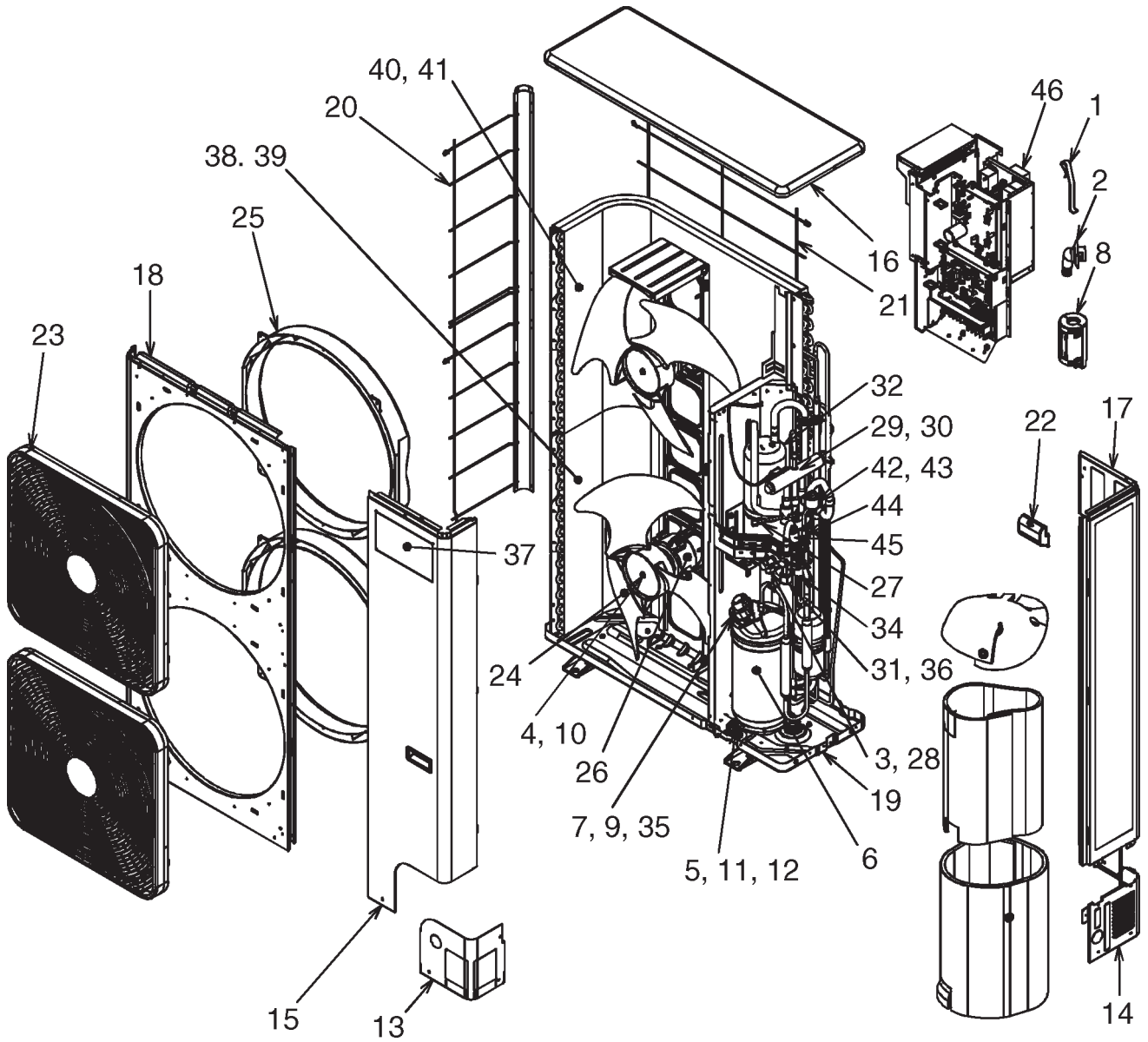

Location No.	Part No.	Description	Model name	RAV-GP
			1401AT8-E 1401AT8-TR	1401AT8J-E 1401AT8J-TR
1	43F19904	HOLDER, SENSOR (TS)	3	3
2	43F32441	NIPPLE, DRAIN	1	1
3	43F47401	BONNET, 3/8 IN	1	1
4	43F47669	NUT, FLANGE	2	
5	43049739	CUSHION, RUBBER	3	3
6	43141530	COMPRESSOR, RX420A3F-27M	1	1
7	43F50407	THERMOSTAT,BIMETAL	1	1
8	43F60029	FILTER, NOISE	1	1
9	43F63317	HOLDER,THERMOSTAT	1	1
10	43197164	NUT, FLANGE		2
11	43197174	NUT, COMP		3
12	43F97212	NUT	3	
13	43100437	PANEL, FRONT, PIPING	1	1
14	43100438	PANEL, BACK, PIPING	1	1
15	43100439	PANEL, FRONT	1	1
16	43100440	PLATE, ROOF	1	1
17	43100470	PANEL, SIDE	1	1
18	43100442	PANEL, AIR OUTLET	1	1
19	43100443	BASE ASSY	1	1
20	43107274	GUARD, FIN, SIDE	1	1
21	43107275	GUARD, FIN, BACK	1	1
22	43107276	HANGER	3	3
23	43119540	GUARD, FAN ASSY	2	2
24	43120244	FAN, PROPELLER, PB521	2	2
25	43122113	BELL MOUTH	2	2
26	4312C100	MOTOR, FAN, ICF-280-A100-1 (A)	2	2
27	43146676	JOINT,CHECK	1	1
28	4314N092	VALVE, PACKED, 9.52	1	1
29	37546878	VALVE, 4-WAY, STF-H0404	1	1
30	4314N080	COIL, SOLENOID, STF-H01AJ1736A1	1	1
31	43146724	VALVE, BALL, SBV-JA5GTC-1, ROHS	1	1
32	43148294	ACCUMULATOR	1	1
34	43151301	SWITCH, PRESSURE	1	1
35	43160612	LEAD ASSY, COMPRESSOR	1	1
36	43147194	BONNET, 5/8 IN	1	1
37	4311M659	MARK, TOSHIBA	1	1
38	4314G266	CONDENSER ASSY, DOWN	1	
39	4314G268	CONDENSER ASSY, DOWN		1
40	4314G269	CONDENSER ASSY, UP	1	
41	4314G271	CONDENSER ASSY, UP		1
42	4314N023	VALVE, PLUS, MODULAING, UKV-25D100	1	1
43	4314N025	COIL, PMV, UKV-A038	1	1
44	4314Q031	STRAINER	1	1
45	4314Q032	STRAINER	1	1
46	43158227	REACTOR	1	1

Outdoor Unit

RAV-GP1601AT8-E, RAV-GP1601AT8J-E
RAV-GP1601AT8-TR, RAV-GP1601AT8J-TR

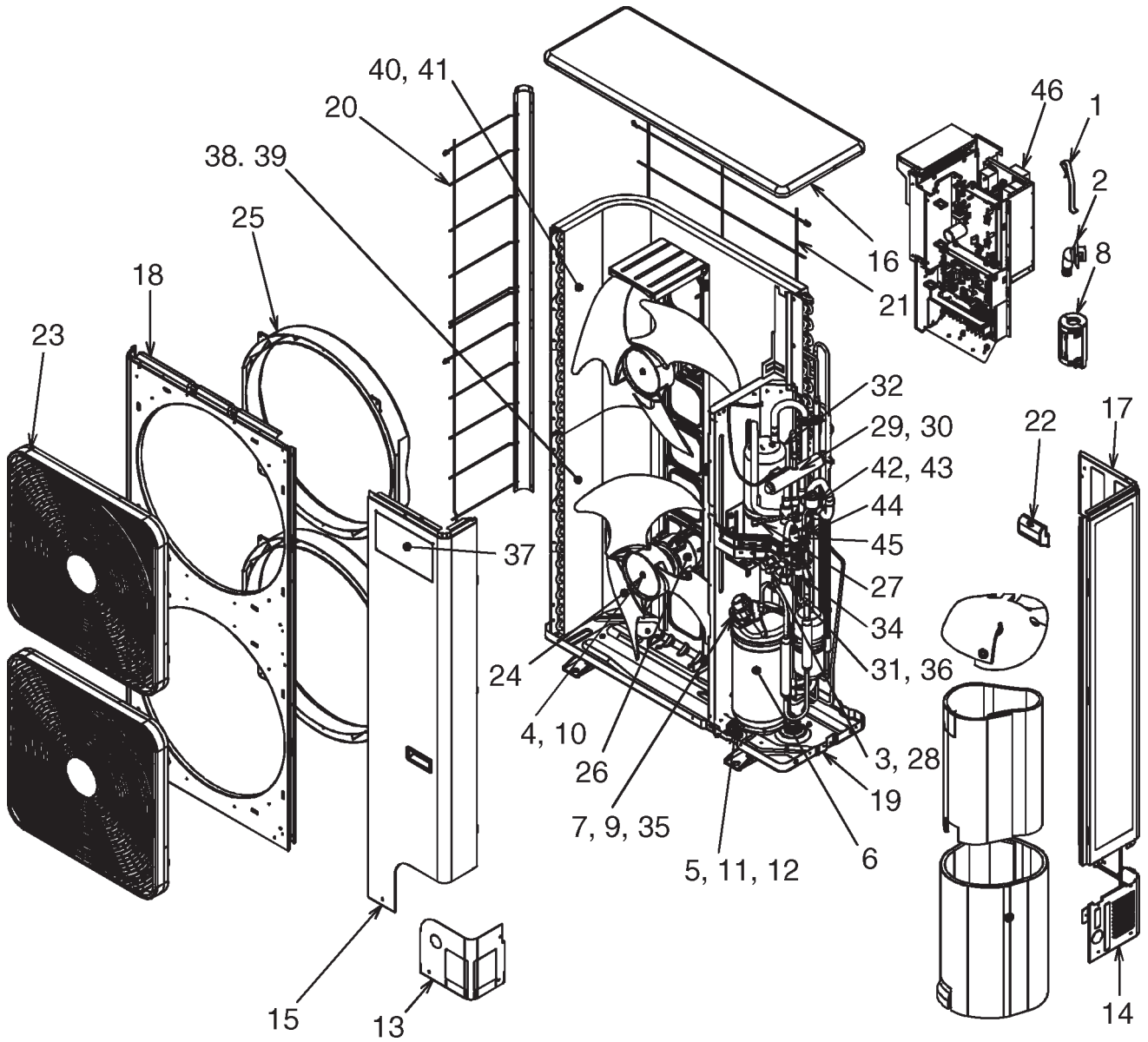

Location No.	Part No.	Description	Model name	RAV-GP
			1601AT8-E 1601AT8-TR	1601AT8J-E 1601AT8J-TR
1	43F19904	HOLDER, SENSOR (TS)	3	3
2	43F32441	NIPPLE, DRAIN	1	1
3	43F47401	BONNET, 3/8 IN	1	1
4	43F47669	NUT, FLANGE	2	
5	43049739	CUSHION, RUBBER	3	3
6	43141530	COMPRESSOR, RX420A3F-27M	1	1
7	43F50407	THERMOSTAT,BIMETAL	1	1
8	43F60029	FILTER, NOISE	1	1
9	43F63317	HOLDER,THERMOSTAT	1	1
10	43197164	NUT, FLANGE		2
11	43197174	NUT, COMP		3
12	43F97212	NUT	3	
13	43100437	PANEL, FRONT, PIPING	1	1
14	43100438	PANEL, BACK, PIPING	1	1
15	43100439	PANEL, FRONT	1	1
16	43100440	PLATE, ROOF	1	1
17	43100470	PANEL, SIDE	1	1
18	43100442	PANEL, AIR OUTLET	1	1
19	43100443	BASE ASSY	1	1
20	43107274	GUARD, FIN, SIDE	1	1
21	43107275	GUARD, FIN, BACK	1	1
22	43107276	HANGER	3	3
23	43119540	GUARD, FAN ASSY	2	2
24	43120244	FAN, PROPELLER, PB521	2	2
25	43122113	BELL MOUTH	2	2
26	4312C100	MOTOR, FAN, ICF-280-A100-1 (A)	2	2
27	43146676	JOINT,CHECK	1	1
28	4314N092	VALVE, PACKED, 9.52	1	1
29	37546878	VALVE, 4-WAY, STF-H0404	1	1
30	4314N080	COIL, SOLENOID, STF-H01AJ1736A1	1	1
31	43146724	VALVE, BALL, SBV-JA5GTC-1, ROHS	1	1
32	43148294	ACCUMULATOR	1	1
34	43151301	SWITCH, PRESSURE	1	1
35	43160612	LEAD ASSY, COMPRESSOR	1	1
36	43147194	BONNET, 5/8 IN	1	1
37	4311M659	MARK, TOSHIBA	1	1
38	4314G266	CONDENSER ASSY, DOWN	1	
39	4314G268	CONDENSER ASSY, DOWN		1
40	4314G269	CONDENSER ASSY, UP	1	
41	4314G271	CONDENSER ASSY, UP		1
42	4314N023	VALVE, PLUS, MODULAING, UKV-25D100	1	1
43	4314N025	COIL, PMV, UKV-A038	1	1
44	4314Q031	STRAINER	1	1
45	4314Q032	STRAINER	1	1
46	43158227	REACTOR	1	1

14-2. Inverter Assembly

RAV-GP1101AT8(J)-E, RAV-GP1401AT8(J)-E, RAV-GP1601AT8(J)-E
 RAV-GP1101AT8(J)-TR, RAV-GP1401AT8(J)-TR, RAV-GP1601AT8(J)-TR

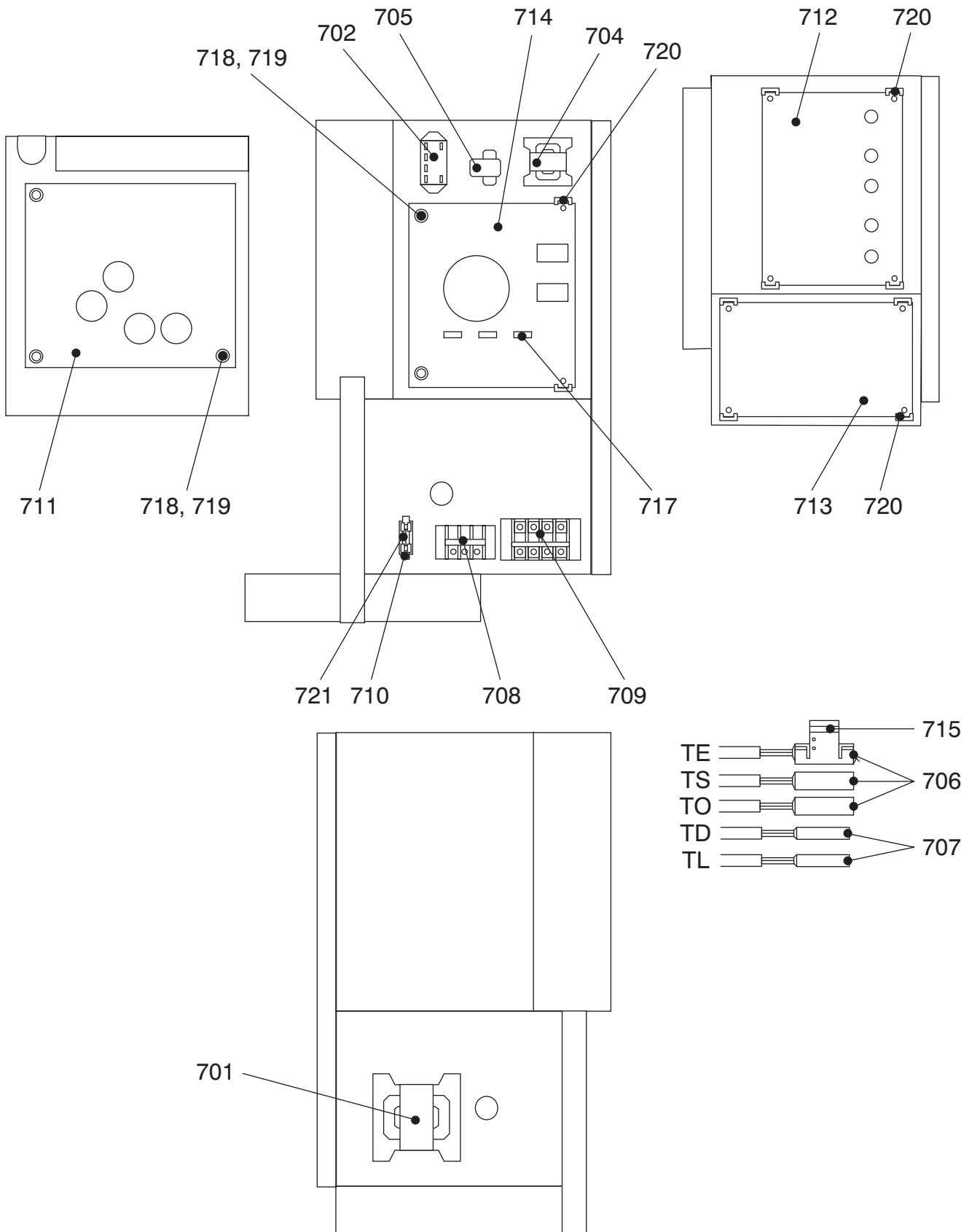

Location No.	Part No.	Description	Model name	RAV-GP
			1101AT8(J)-E, 1401AT8(J)-E, 1601AT8(J)-E 1101AT8(J)-TR, 1401AT8(J)-TR, 1601AT8(J)-TR	
701	43F58288	REACTOR, CH-56-4Z		1
702	43154177	RELAY		1
704	43158207	REACTOR, CH-68		1
705	43153006	PTC-THERMISTOR		1
706	43050425	SENSOR ASSY, SERVICE		3
707	43150319	SENSOR ASSY, SERVICE		2
708	43160565	TERMINAL BLOCK, 3P, 20A		1
709	43160579	TERMINAL, 30A, 4P		1
710	43F60859	FUSE BLOCK, 30A, 250V		1
711	4316V416	PC BOARD ASSY, MCC-1596, COMP-IPDU		1
712	4316V391	PC BOARD ASSY, MCC-1597, FAN-IPDU		1
713	4316V622	PC BOARD ASSY, MCC-1599, CDB		1
714	4316V398	PC BOARD ASSY, MCC-1600, N/F		1
715	43F63325	HOLDER, SENSOR (TE)		1
717	43160590	FUSE		3
718	43282001	BUSHING		5
719	43183020	COLLAR		5
720	43F63248	SUPPORTER, ASSY		2
721	43060700	FUSE, 10A, 250V		1

Toshiba Carrier Corporation

72-34 Horikawa-cho, Saiwai-ku, Kawasaki-shi, Kanagawa 212-8585, JAPAN

Copyright © 2019 TOSHIBA CARRIER CORPORATION, ALL Rights Reserved.